



The wise choice for
Ultra Reliable Bearings

BEARINGS USER'S HANDBOOK



MAINTENANCE
and
SERVICE





The wise choice for
Ultra **R**eliable **B**earings

**BEARINGS
USER'S HANDBOOK**

TABLE OF CONTENT:

1. BEARING DESIGNATION AND IDENTIFICATION	4
1.1. Identification of bearings.....	4
2. SUGGESTIONS FOR THE SELECTION OF BEARING TYPE.....	5
2.1. Selection of bearing type according to the direction and magnitude of loads.....	5
2.2. Bearing selection according to rotational speed and operating temperature.....	10
2.3. Bearing type selection according to rotational precision and noise conditions required	12
2.4. Selection of a bearing type according to permissible deviations of concentricity.....	12
2.5. Bearing selection according to its role within the assembly (locating or non-locating bearing).....	12
2.5.1. Bearing axial location.....	13
2.5.2. Compensation of thermal dilatations of the pieces in connection with the bearings	13
3. MOUNTING SPECIFICATIONS IN BEARING ASSEMBLIES.....	14
3.1. Loading modes of bearing rings.....	14
3.2. Selecting the bearing fits	16
3.2.1. Tolerance classes for shafts	16
3.2.2. Tolerance classes for housing bores	16
3.2.3. Special fits for some types of bearings	16
3.3. Bearing sealing	18
3.3.1. Stationary seals.....	19
3.3.2. Rotary seals	19
3.3.2.1. Non-rubbing seals	19
3.3.2.1.1. Gap rotary non-rubbing seals.....	19
3.3.2.1.2. Labyrinth seals.....	19
3.3.2.2. Rubbing seals	20
4. BEARINGS LUBRICATION	22
4.1. Lubricant selection	22
4.2. Liquid lubricants.....	26
4.2.1. Selection of liquid lubricants.....	26
4.2.2. Liquid lubricants circulating systems.....	27
4.3. Consistent lubricants (greases)	28
4.3.1. Selection of consistent lubricants	28
4.3.2. Lubricant quantity and relubrication intervals	28
4.3.3. Consistent lubricants feeding systems.....	29
5. BEARINGS STORAGE AND HANDLING.....	30
6. MOUNTING OF BEARINGS.....	31
6.1. The preparation of components for the mounting procedure	31
6.1.1. The preparation of new bearings	31
6.1.2. The preparation of used bearings	31
6.1.3. Shafts preparation for bearings mounting	31
6.1.4. The preparation of housing.....	32
6.1.5. The preparation for the mounting of the axial fixing elements	33
6.2. Bearing mounting devices	33
6.2.1. Generalities.....	33
6.2.2. Mounting of bearings with cylindrical bore	34
6.2.3. Mounting of cylindrical roller bearings.....	35
6.2.4. Mounting of taper bore bearings	35
6.3. Performance test.....	37
7. DISMOUNTING OF BEARINGS	39
7.1. Rules in bearings dismounting.....	39
7.2. Bearing dismounting devices	40
7.2.1. Dismounting of bearings with cylindrical bore	40
7.2.2. Dismounting of taper bore bearings	42
8. PREVENTIVE MAINTENANCE OF BEARINGS	42
9. BEARINGS EXAMINATION. FAILURE REASONS.....	43

1. BEARING DESIGNATION AND IDENTIFICATION

Bearing designation must allow the identification of every bearing so that the bearings marked by the same symbol could be dimensionally and operationally exchangeable.

The symbol of a bearing consists of:

- basic symbol
- additional symbols
 - prefixes
 - suffixes

The composition of a bearing symbol is illustrated in the diagram below representing the normal order of characters (numbers and letters) for different symbol components.

Prefixes		Basic symbols			Suffixes			
					Group I	Group II	Group III	Group III
Materials	Special designs, component parts	Bearing type	Dimension series	Bore diameter identification	Internal design, contact angle	Constructive characteristics, taper, seals	Cages, materials, guiding surfaces	Tolerance class, clearance
		Bearing series designation						

1.1. Identification of bearings

Example of symbols:

- Bearing **X-6203-2-RSRP6 38EL**

Stainless steel bearing (symbol X); single row deep groove ball bearing, (symbol 6); dimensions series 02 (symbol 2); with bore diameter d=17 mm (symbol 03); with seals on both sides, with friction on the recess of the inner ring (symbol 2RS); in P6 precision class (symbol P6); radial clearance C3 (symbol 3); security class C8 (symbol 8); EL vibration class (symbol EL).

- Bearing **T-NUP315-EMP63S1TR**

Case-hardening steel bearing (symbol T); single row cylindrical roller bearing with support washer (symbol NUP); dimensions series 03 (symbol 3); with bore diameter d=75 mm (symbol 15); with increased basic load (symbol E); brass cage (symbol M); precision class P6 (symbol P6); radial clearance C3 (symbol 3); for operating temperatures up to 200⁰ C (symbol S1); for electrical traction motors (symbol TR).

2. SUGGESTIONS FOR THE SELECTION OF BEARING TYPE

2.1. Selection of bearing type according to the direction and magnitude of loads

The magnitude and direction of loads greatly influence the selection of bearings.

Generally, for the same dimensions, the cylindrical roller bearing stands heavy loads than the deep groove balls bearing. The bearings with more rows of rolling elements, especially rollers have heavy load carrying capacity. According to the load acting direction, the following situation are distinguished:

a. Radial load

Cylindrical roller bearings without ribs at one of the rings, with one row of rollers (type N or NU) or with two rows of rollers (type NN or NNU) and needle roller bearings are to be used.

b. Axial load

Thrust balls or roller bearings according to the load magnitude, are to be used. The simple effect thrust roller bearings can be loaded only in a single direction and the double effect thrust roller bearings can be loaded in both directions.

c. Combined load

The simultaneous action of radial and axial load means that on the roller bearing acts a combined load.

For light axial loads together with radial loads are used:

- Deep groove ball bearings, single row. (Combined load supported rises if the radial clearance is greater than normal);
- Cylindrical roller bearings of the NUP and NJ+HJ types and spherical roller bearings.
- NJ type cylindrical roller bearings can only accommodate axial loads acting in a single direction and for axial displacement of the shaft in both directions it is recommended to mount roller bearings of the same type.

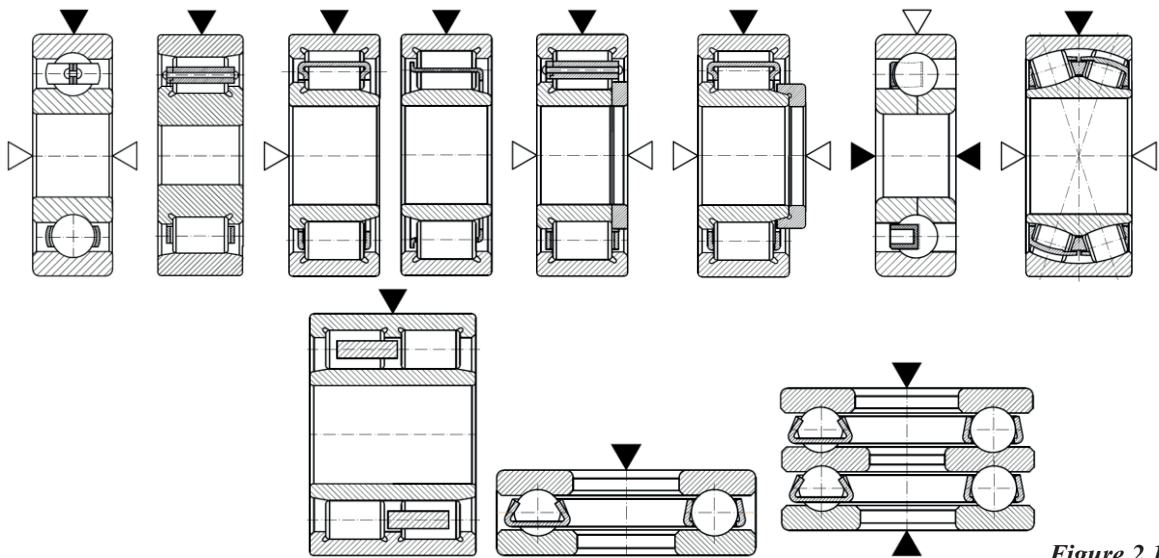

Figure 2.1

If the axial load is heavy, a thrust bearing must be mounted together with a radial roller bearing. The angular contact balls bearing or four-point contact bearings (Q or QJ type) used when axial load predominates are mounted with clearance fit for housing.

In case of combined loads in which heavy axial load predominates, angular contact ball bearings single or double rows taper roller bearings or spherical roller thrust bearings. The above are presented in figure 2.1. in which the black triangles indicate the loads direction for which the respective bearing was designed and the white triangles are indicating the possible loads.

The size of the bearings is selected considering the condition of life requirements ensuring for imposed conditions of load, rating life and reliability of operation. Selection is done on the basis of a characteristic variable: **basic load ratings**.

d. Basic static load

Basic static load, C_{0r} , is given in the bearings catalogues for every size and it is taken in consideration when the bearing is stationary, has slow oscillations, low speed ($n < 10$ rot/min) or when during the rotating these must support heavy shock loads. In this case, the operation safety is determined by the size of the deformations of the raceway of the bearing.

Basic static load is determined according to ISO 76 and represents the load that produces a permanent deformation of 0.0001 from the diameter of the rolling element, the load being purely radial for radial bearings and purely axial for thrust bearings.

The combined static load (radial and axial loads that are acting simultaneously on a bearing) must be converted into an equivalent load which results from the general formula:

$$P_0 = X_0 \cdot F_r + Y_0 \cdot F_a \quad [kN]$$

where: P_0 equivalent static load of the roller bearing, [kN]

F_r the radial component of the heavy static load in [kN]

F_a the axial component of the heavy static load in [kN]

X_0 the radial load factor of the bearing

Y_0 the axial load factor of the bearing

X_0 and Y_0 are given in the bearings tables and catalogues according to the type of the bearing and ratio F_a/F_r .

Knowing the shaft diameter "d", the size of the bearing is determined from the condition of inequality:

$$C_{0r} \geq s_0 \cdot f_{0t} \cdot P_0 \quad [kN]$$

where: s_0 is a static safety factor coefficient chosen according to table 2.1 (for the non-rotating bearings or for the bearings with oscillating movements) and table 2.2 (for rotating- bearings subject to oscillating loads or heavy shock loads with short duration).

Application	s_0	Load type	Silent running requirements (without noise)					
			Low		Normal		High	
Adjustable pitch airscrew for planes	0,5		Bearings balls	roller	Bearings balls	roller	Bearings balls	roller
Gates of barrages, dams, flood gates	1							
Mobile bridges	1.5	Smooth, without vibrations	0,5	1	1	1,5	2	3
Crane hooks for:		Normal	0,5	1	1	1,5	2	3,5
• small cranes, with additional dynamic loads	1.6	Heavy shock loads	>1,5	>2,5	>1,5	>3	>2	>4
• large cranes, without additional loads	1.5							

Table 2.1

Table 2.2

The heavy shock loads that are higher than the basic static load of the bearing are producing residual deformations not uniformly distributed on raceway which negatively influence the good operation of the roller bearing.

At high operating temperatures C_{0r} is corrected with the following factor:

Temperature	150°C	200°C	250°C	300°C
f_{0t}	1	0,95	0,85	0,75

When more bearings of the same type are mounted close together, the static load supported will be determined with the following relation:

$$C_{0ri} = C_{0r} \cdot i \quad [kN]$$

where: C_{0ri} - basic static load of the bearing group, [kN]

C_{0r} - basic static load of the single bearing taken from tables, [kN]

i - number of bearings.

e. Basic dynamic load

For the bearings in which at least one of the rings rotates with a rotation speed $n > 10$ rot/min, the operation in safety is mainly determined by the contact fatigue or abrasive wear. Considering of a foremost importance the contact fatigue failure phenomena (apparition of pitting or material spalling), the value of basic dynamic load, C_r , is indicated in bearing catalogues for each type dimension. This represents the allowable load for which the bearing has a rating life of 1 million rotations and it is determined according to ISO 281.

The basic dynamic load for the achievement of the required rating life and for the shaft diameter "d" is derived from the following inequality:

$$C_r \geq (L_{10})^{1/p} \cdot P_r, [kN]$$

where: L_{10} - basic rating life, in millions of revolutions

P_r - equivalent dynamic load, [kN]

p - exponent of the life equation having the following values:

- $p=3$ for balls bearings
- $p=10/3$ for roller bearings

Having known the L_h basic rating life in hours and rotation speed n , in rev/min, the variable L_{10} is determined with the following relation:

$$L_{10} = (n \cdot L_h \cdot 60) / 10^6, [millions\ of\ rotations]$$

The equivalent dynamic load, P_r , is determined with the following relation:

$$P_r = f_d \cdot (X \cdot F_r + Y \cdot F_a), [kN]$$

$$f_d = f_k \cdot f_s \cdot f_r$$

where: f_d - the dynamic coefficient which takes into account the fact that the forces acting on bearings display deviations due to execution errors of the devices transmitting the movement, vibrations);

f_k = coefficient due to the precision of the gear on the shaft of the calculated bearing is mounted;

f_s = coefficient due to the additional forces specific to machine operation;

f_r = coefficient taken into account only for shafts and axles bearings for the vehicles wheel. In other cases $f_k = f_r = 1$

The equivalent dynamic load P_r is calculated according to the type of bearing for which the values of X and Y factors (radial load factor respective axial load factor for the bearing) are given in catalogues and bearing tables, determined by the ratio:

$$e = F_a / F_r$$

where: F_r - radial component, [kN];

F_a - axial component, [kN].

In many operation cases, the size of the load and rotational speed are variable, when an average constant radial F_{mr} or axial F_{ma} load must be calculated for the calculus of the dynamic equivalent load.

- i. If at constant rotational speed the force acting on the rolling bearing linearly varies between a minimum value $F_{mr, a_{min}}$ and a maximum value $F_{mr, a_{max}}$, keeping its direction within a certain interval of time, the medium load results from the following relation:

$$F_{mr, n} = (F_{r, a_{min}} + 2 \cdot F_{r, a_{max}}) / 3, [kN]$$

- ii. If the radial load that acts on a rolling bearing is made of a force F_{r1} which is constant in size and direction (for example the weight of a rotor) and a constant rotation force F_{r2} (for example the unbalancing phenomena), the average load results from:

$$F_m = f_m \cdot (F_{r1} + F_{r2}), [kN]$$

The values for f_m coefficient are obtained from the figure 2.2

- iii. For a radial load, F_r applied on bearing which oscillates from a central position through an angle 2γ (see figure 2.3), the average radial load is done by the following relation:

$$F_{mr} = f_0 \cdot F_r, [kN]$$

with values for f_0 coefficient given in table 2.3 according to the oscillation angle γ and the exponent of the life formula, p .

For variable loads in size, time and direction and for different rotational speeds, the average dynamic loads given by the following formula:

$$F_{mr, a} = [\Sigma (F_{ir, a} \cdot p \cdot n_i) / n]^{1/p}, [kN]$$

$$n = \Sigma n_i, [rot/min]$$

where:

$F_{mr,a}$ - average constant load, radial or axial, [kN]

$F_{ir,a}$ - constant loads applied on the duration of effecting of rotations n_i , [kN]

n_i - the no. of rotations corresponding to $F_{ir,a}$ loads

$p = 3$ for ball bearings and; $10/3$ for roller bearings

If the required basic dynamic load is greater than all values indicated in the catalogue for shaft diameter, d , the following solutions could be considered:

- selection of another bearing type that secures for the same diameter d , superior basic dynamic loads when the other restrictions (rotational speed, dimensions, possibility of supporting the type of the applied loads) are satisfied;
- improvement of the shaft diameter (if constructive and mounting condition allow this);
- assembling two or even more identical bearings, the base dynamic load of the i bearings assembly being calculated with the following relation:

- for punctual contact bearings;

$$C_r = i^{0.7} \cdot C_{ri} \text{ [kN]}$$

- for linear contact bearings.

$$C_r = i^{7/9} \cdot C_{ri} \text{ [kN]}$$

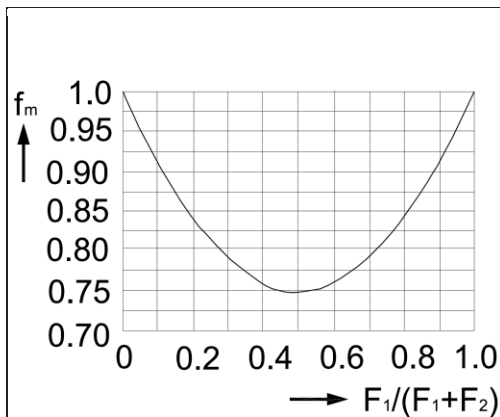

Figure 2.2

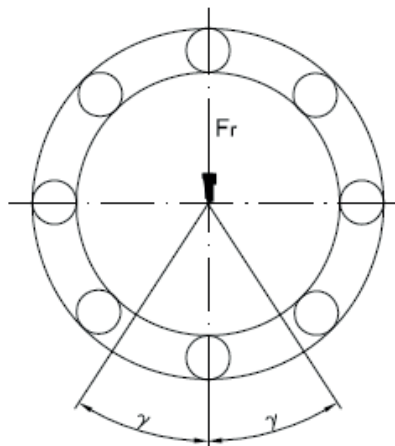

Figure 2.3

γ^0	f_0	
	$p=3$	$p=10/3$
10	0,47	0,53
20	0,61	0,65
30	0,69	0,72
45	0,79	0,81
60	0,87	0,89
75	0,94	0,95
90	1,0	1,0

Table 2.3

To take evenly the loads, these bearings must be paired so that the diameter and radial clearance deviations are max. 1/2 of the allowed tolerance field. Relation which refers to the basic dynamic load of the roller bearing indicated in roller bearing tables depends on "basic rating life" (L_{10}) which, according to ISO 281 means the life attained or exceeded by 90% of the bearing group of the same type dimension operating in the same conventional conditions (good mounting, protection against foreign particles penetration, correct lubrication, correct loading, non-exposed to extreme speeds and temperatures). After bearing selection (according to the basic dynamic load), it is recommended to determine its effective life (adjusted rating life for conditions different from those mentioned in ISO 281) with the following relation:

$$L_n = a_1 \cdot a_2 \cdot a_3 \cdot f_t \cdot (C_r/P_r)^p$$

where: L_n – adjusted rating life (mil. of rotations);

a_1 - correction factor that takes into account the reliability (table 2.4);

a_2 - correction factor that takes into account the quality of the material and manufacturing technology (for materials and technologies used for manufacturing URB bearings $a_2 = 1$);

a_3 - correction factor that takes into account the operating conditions and lubrication quality.

f_t – correction factor according to the operation temperature (table 2.6).

The connection between these two last connection factors leads to their fusion into a single factor, a_{23} , whose value is given in table 2.5 and depends on the ratio between the cinematic viscosity of the oil at 40°C, ν initial in cSt or mm²/s (see figure 2.4) and the viscosity required for a correct lubrication at the operation temperature, ν_1 (see figure 2.5).

Reliability, %	L_{na}	a_1
90	L_{10a}	1
95	L_{5a}	0,62
96	L_{4a}	0,53
97	L_{3a}	0,44
98	L_{2a}	0,33
99	L_{1a}	0,21

Table 2.4

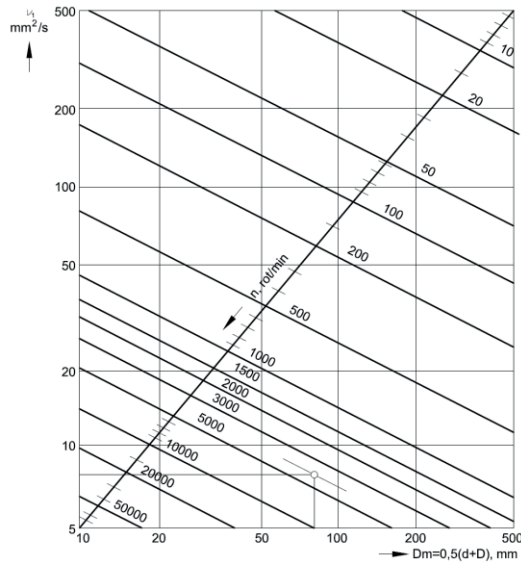

Figure 2.4

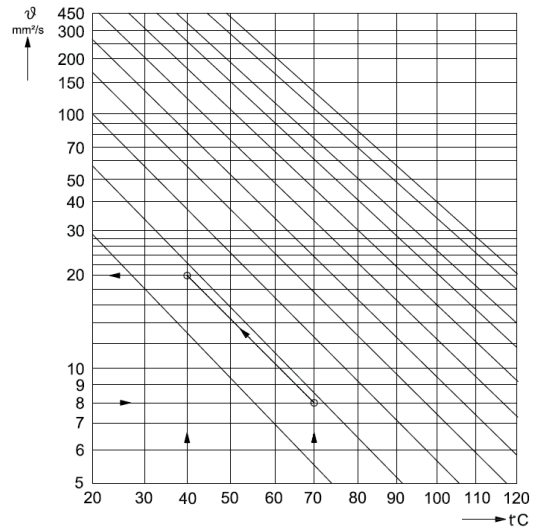

Figure 2.5

Example of calculation of the kinematic viscosity of the oil: For a bearing with $D_m = 85$ mm which operates at a rotational speed of 3500 rot/min, it results from figure 2.4 $v = 8$ mm²/s. From figure 2.5 results that for the operating temperature of 70°C to obtain v_1 viscosity it is required an initial viscosity of $v = 20$ mm²/s.

a. Abrasive wear

In cases of unsuitable operating conditions (abrasive particles contaminated environment, non-coaxial positioning of the roller bearings that facilitates the occurrence of the abrasive wear between the cages and rolling elements) appears an increase of the radial clearance of the bearing.

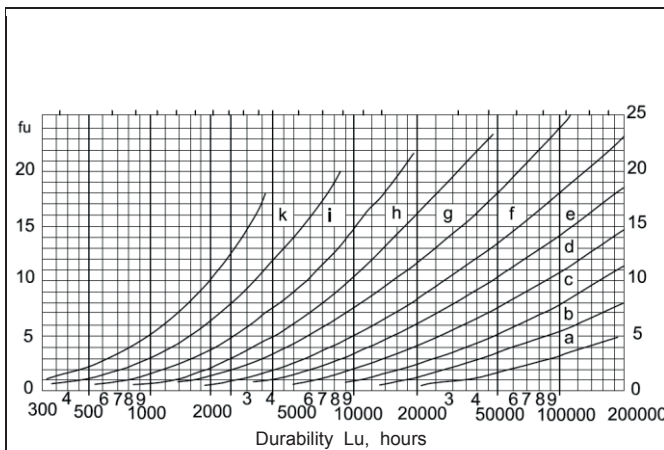

Figure 2.6

$\frac{\vartheta}{\vartheta_1}$	0,1	0,2	0,5	1	1,5	2	3	4	5
a_{23}	0,45	0,55	0,75	1	1,3	1,6	2	2,5	2,5

Table 2.5

Running temperature [°C]	150	200	250	300
f_t	1	0,73	0,42	0,22

Table 2.6



Figure 2.7

The limit increase of the radial clearance:

$$\Delta G_r = f_u \cdot K_u$$

and depends on the roller bearing diameter and its operating conditions determining a certain rating life L_u according to figure 2.6, function of f_u factor which values depend on operating period and conditions (see table 2.7).

K_u is a constant established according to the bore diameter d of the bearing (see figure 2.7).

The rating life L_u determined from abrasive wear failure condition compares itself with the rating life L_n determined from contact fatigue failure condition. As a possible rating life will be taken into account only the minimum value of the two calculated rating life.

Table 2.7

Values of the wear factor f_u and operating domains (see figure 2.6)					
Applications	f_u	Operating domain	Applications	f_u	Operating domain
Small gear units	3- 8	e- g	Steering mechanisms	3-6	i- k
Medium gear units	3- 8	d- e	Household devices engines	3-5	i- k
Small fans	5- 8	f- h	Small engines	3-5	e- g
Medium fans	3- 5	d- f	Medium size engines	3-5	d- e
Large fans	3- 5	c- d	Large engines	3-5	c- d
Centrifugal pumps	3- 5	d- f	Driving engines	4-6	d- e
Centrifugal separating device	2- 4	d- e	Railway axle bearings for truck	12-15	f- h
Hand wheels	8- 12	c- d	Railway axle bearings for tram wagons	8-12	e- f
Rollers for band conveyors	10-30	h- k	Railway axle bearings carriages for passengers	8-12	c- d
Drums for band conveyors	10-15	e- f	Railway axle bearings for goods wagons	8-12	c- d
The drum for the excavator rotating cups	12-15	e- g	Axle bearings for ore carriages	8-12	c- d
Crusher	8-12	f- g	Axle bearings for road train	6-10	d- e
Hammer crusher	4-6	c- d	Locomotive axle bearings (ext., int. bearings)	6-10	d- e
Swinging sieves	4-6	e- f	Gear units for rail vehicles	3-6	d- d
Swinging screens	3-4	g- i	Rolling mills	6-10	e- f
Briquetting presses	8-12	e- g	Gear units for rolling mills	6-12	c- d
Large mixers	8-15	g- h	Centrifugal casting machines	8-12	e- f
Rollers for rotating furnaces	12-18	f- g	Rudder bearings	6-10	e- f
Balance wheels	3-8	d- f	Paper machines, dry part	10-15	a- b
Wheels bearings	4-8	h- i	Idem, refiner cylinders	5-8	b- c
Gearboxes	5-10	i- k	Idem, calenders	4-8	a- b
Bearings for propellers supporting shafts	15-20	e- f	Textile machines	2-8	a- e
Heavy gear units for ships	5-10	c- d	Paper machines, wet part	7-10	b- c

2.2. Bearing selection according to rotational speed and operating temperature

Maximum (limit) rotational speed to which a bearing may be subject to is indicated in bearings tables and catalogues for greasing and oil lubrication

The values are approximate and valid if bearings are used for loads corresponding to a rating life $L_h < 150.000$ hours and operate in the following conditions:

- good rigidity of the shaft and housing
- adequate greasing conditions
- heat dispersing conditions (maximum operating temperature 70°C)
- adequate sealing

In the case in which the bearings operating conditions are not known it is recommended that the effective rotational speed not to exceed 75% of the rotational speed indicated in the catalogue.

For heavy loads applied to bearings with the mean diameter greater than 100 mm when the rating life L_{10} is smaller than 75.000 hours, the limit rotational speed indicated by the catalogue shall be multiplied with the factor f_0 from figure 2.8.

For combined loads applied to bearings, the rotational speed indicated in the catalogue shall be multiplied with the factor f_1 from figure 2.9

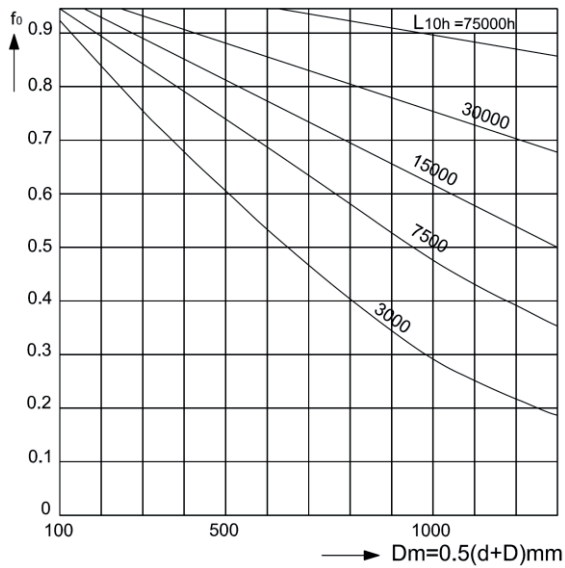

Figure 2.8

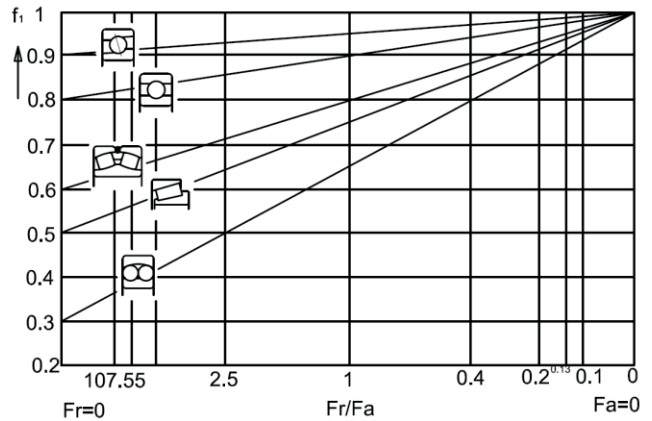

Figure 2.9

The increase of the maximum rotational speed above the limit value mentioned in the catalogue could be realized both through the use of higher precision bearing classes in the same time with the increase of the shaft and housing manufacturing precision and through the improvement of the greasing and cooling conditions.

Table 2.8 presents the multiplication factors of the limit rotational speed.

Constructive features/ Precision class	Greasing type	Bearing type		Bearing type	Allowable rotation angle		
		Radial ball/roller bearing	Axial ball bearing		Degrees	Radians	
Special cage / P6	Oil circulation	1,6 - 1,8	1,1 - 1,3	Radial ball bearing (mounted according to tolerance fields: k5 for shaft and J6 for bore)	Normal clearance	8'	$2,5 \times 10^{-3}$
					C3 clearance	12'	$3,5 \times 10^{-3}$
C4 clearance	16'	5×10^{-3}					
Special cage / P5	Cooled oil circulation	1,8 - 2,1	1,3 - 1,4	Radial roller bearing (modified contact)	N and NU construction, series 10, 2, 3, 4	4'	$1,2 \times 10^{-3}$
	Oil mist				Other series or constructions	2'	$0,6 \times 10^{-3}$
Special cage / P4	Cooled oil circulation	2,1 - 2,4	1,3 - 1,4		Spherical, single-row roller bearing	4°	70×10^{-3}
	Oil spot				Spherical, double-row roller bearing	0,5°	$8,7 \times 10^{-3}$
				for light loads	2°	35×10^{-3}	

Table 2.8

Table 2.9

For high rotational speed the bearings of small size series are to be preferred.

In case of pure radial loads carrying, radial ball or roller bearings can support the higher rotational speeds.

In the case of combined loads carrying, even in the case in which the axial loads are foremost will be preferred radial - axial ball bearings.

In the case of spherical (ball or roller) bearings when axial loads are predominating, it is recommended to reduce the upper limit of the maximum rotational speed.

For all bearings used at high rotational speeds it is recommended the use of a radial clearance greater than the normal one (groups C3, C4, C5).

Maximum operating temperature to which the bearings designed for normal applications can be used is of 120°C. Over this temperature in the material of the contact elements (rings and rolling elements) there are produced structural transformations with *negative implications* over the dimensional stability and physical and

mechanical characteristics which determine the resistance to contact fatigue and, through implication, to the life of the bearing.

Thus, at higher temperatures it is recommended to use special bearings having the component parts made of special steel brands or stabilized through thermal treatments. These bearings have special symbols.

Remark: When the working conditions of bearing allow great temperature differences in operation for the two rings (interior and exterior) we recommend the use of bearings with radial clearance greater than normal (groups C3, C4, C5).

2.3. Bearing type selection according to rotational precision and noise conditions required

A bearing precision class is chosen according to the prescriptions imposed to the rotational precision for the shaft of mechanism (radial and axial wobbling). For the great majority of the mechanisms in machines engineering are used P0 precision class bearings.

The use of higher precision bearings (P6, P5, P4) is imposed in the case of special applications: *high rotational speed, very low noise level, high movement precision.*

Examples of such assemblies are bearings for the main shafts of rectifying and precision-finishing machines, bearings of precision devices (measuring, control or medical devices), engines bearings, etc.

It must be taken into account the fact that a bearing even ideally manufactured will generate noise when operating having the pieces in contact with it and mainly the shaft and the housing will modify through their low precision the ideal form of a bearing components or they will determine an axial displacement or a tilting of the rings over the established limits.

Having in view the above mentioned, to reduce the level of vibrations and noise produced by the bearings, it is recommended that:

- the tolerances established for form and position deviations of shafts and housings must be by two or three classes more accurate than those mentioned for normal precision bearings;
- very clean lubricants be employed, granting special attention to handling, greasing and sealing the bearings;
- bearings with radial clearance smaller than normal must be employed;
- the exaggerate pre-load of the bearing that produces elastic deformation of the rings that allow to noise increasing must be avoided.

We mention that the noise level in bearings increases linearly with the bore diameter. Also, in roller bearings the noise level is greater than in ball bearings.

2.4. Selection of a bearing type according to permissible deviations of concentricity

In some constructions it is very difficult to avoid the angular deviations, shaft tilting and housing deformation. These could be produced when:

- the distances between bearings are large;
- the bores of the two housings could not be processed through a single fixing;
- the housings are fixed on different foundations or on welded metallic constructions.

In these cases will be selected mainly spherical bearing types, the bearing type being determined by the tilting angle between the inner and the outer rings. (see table 2.9). The use of bearings in constructions in which coaxially deviation between shaft and housing exceeds the permitted limit leads to their rapid failure. We mention that bearings with spherical exterior surface (Type Y truck runner bearings) are not designed to process continuous oscillating movements.

Continuous compensation of the angular deviations is best achieved in spherical roller bearings.

2.5. Bearing selection according to its role within the assembly (locating or non-locating bearing)

According to the mode in which the two bearings of the assembly take part in the process of taking over the axial forces that load the shaft, there are two bearing solutions:

a. fixed or locating bearing (driving) and free or non-locating bearing (driven);

This solution is recommended in case of medium or large length shafts where temperature variations during operation are possible.

The *fixed bearing* has the role to take over the due radial reaction and the entire axial force of the shaft, in both directions.

The *driving bearing* is fixed both on the shaft and on the housing for this establishing the bearing that is radially light loaded. As driving bearing can be used any bearing which can support combined loads.

The *free bearing* takes over the radial reaction allowing in the same time the axial displacement against the housing, avoiding thus an additional loading of the bearings with axial forces following the thermal

dilatation of the shaft. The axial displacement could be obtained inside a bearing using cylindrical roller bearings without ribs (type N or NU).

In case of significant axial displacements, it is provided to move the entire roller bearing using an adequate fit between the outer ring and the housing.

If the outer ring rotates, the axial displacement can be realized between the inner ring and the shaft.

In case of shaft supported by more bearings, one of them will be axially fixed, the other ones being free to move axially. In case of cross location the two bearings are mounted in opposition, the shaft being guided by every bearing only in a single direction. This system is especially recommended only for short shafts. The shafts and bores in which the opposite bearings are to be mounted must be axially tolerated so that operation must not produce a pre-straining of the bearings.

b. cross location (interchangeable).

2.5.1. Bearing axial location

In order to achieve an axial location of bearings there is a great number of solutions according to the bearing type and magnitude of load to be taken over. Figure 2.10 presents schematic examples of axial location for fixed bearings and figure 2.11 presents the same for free bearings..

In cases in which no axial load is transmitted through a certain bearing, a ring could be used of an interference fit only.

The most common axial location system is performed by means of cover, nuts and screw plates etc. through axial supporting of the bearing rings.

For light axial loads, axial location systems could be achieved by means of safety rings.

Due to a low height of the safety rings and of exterior connecting radius of the bearings rings, sometimes intermediate rings are required, mounted between the bearing and the safety ring.

When a low interference fit is used for the inner ring in order to avoid its rotation against the shaft, a lock washer will be introduced between the bearing ring and the lock nut.

The lock washer will have a tenon that entering in a groove in the shaft will disconnect the transmission of the friction forces to the nut thus eliminating the danger of breaking the lock nuts.

Another axial location system is achieved through the taper pressed assemblies, using adapter or withdrawal sleeves.

This system is possible only for tapered bore roller bearings and has the following advantages:

- heavy axial loads could be taken over in both directions;
- it is not necessary a high manufacturing precision for the shaft;
- ensures an easy mounting and dismounting.

It is however necessary to support the inner ring of the bearing on the shaft collar or on a snap ring which in case of using the withdrawal sleeve prevents the axial displacement for heavy axial loads and in the case of adapter sleeve it facilitates bearing dismounting.

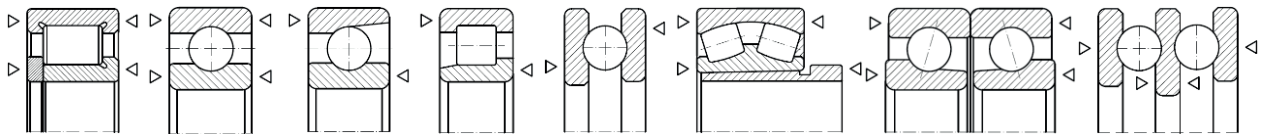

Figure 2.10

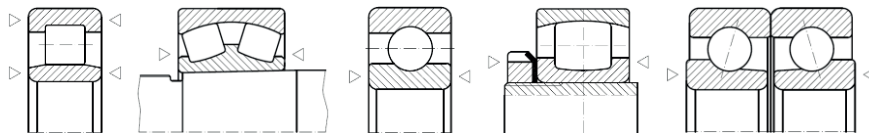

Figure 2.11

2.5.2. Compensation of thermal dilatations of the pieces in connection with bearings

In case when the shaft elongation determined by the increase of the temperature of the bearing assembly during operation is not taken over by a non-locating bearing, the axial clearance of the bearing is reduced, the result being the jamming of the component part of the roller bearing (rings and rolling elements) reducing its life. The size of shaft elongation with the temperature is illustrated by the following relation:

$$\Delta l = \alpha \cdot l \cdot (t_2 - t_1), [mm]$$

where: t_2 - shaft working temperature, [$^{\circ}C$]; t_1 - environment temperature, [$^{\circ}C$];

l - length of the shaft, [mm]; α - thermal dilatation coefficient for the shaft [$^{\circ}C$] $^{-1}$.

The axial clearances between rotating pieces and fixed pieces of the labyrinth sealing devices must be enough large so that the thermal dilatation of the shaft does not determine frictions between these pieces.









3. MOUNTING SPECIFICATIONS IN BEARING ASSEMBLIES

3.1. Loading modes of bearing rings

The selection of the bearings mounting fits depends on the type and magnitude of bearing, on operating conditions (lubrication, temperature etc.) and also on the loads direction and magnitude. The greater the loads with chokes on the rotating load ring, the greater the fit tightening.

According to the direction of the load that acts on the bearing, there are three cases of ring loading (presented in table 3.1):

Table 3.1

Ring		Operating conditions		Ring	
inner	outer	Load	Draft	inner	outer
				Load	
It rotates	It doesn't rotate	The resultant load has a constant direction		Rotating	Stationary
It doesn't rotate	It rotates	The resultant load rotates with the outer ring		Stationary	Rotating
It rotates	It doesn't rotate	The resultant load rotates at the same time with the inner ring		Rotating	Rotating
It doesn't rotate	It rotates	The resultant load has a constant direction		Stationary	Rotating
It rotates	It doesn't rotate	P_{rot} load rotates together with the inner ring P_c load has a constant direction $P_{rot} < P_c$		Rotating	Rotating
It doesn't rotate	It rotates	P_{rot} load rotates together with the outer ring P_c load has a constant direction $P_{rot} < P_c$		Rotating	Rotating
Both rings are rotating in the same or opposite directions with different rotation speed		The resultant has a constant direction		Rotating	Rotating
		The resultant load rotates together with the inner ring		Stationary	Rotating
		The resultant load rotates together with the outer ring		Rotating	Stationary

- Carrying with stationary load when the load (resultant) is continuously oriented towards the same point of the raceway. The ring subject of a stationary load can be mounted with clearance fit (h6, g6, j6, H7, H8, G7).
- Carrying with rotating load when the resultant load is successively supported on all circumference of the bearing raceway or only on a portion of this circumference. The ring subject to a rotation load must be mounted with tight fit (j5, k6, m5, m6, p6, r6, H6, J6, J7, K6, K7, M7, N7).

c. Undetermined carrying, when the load has undefined variable directions from the bearing rings (shocks, vibrations or unbalance motions in high rotation speed machines). In case of the undetermined carrying, both rings are to be mounted with tight fit.

The magnitude of the load is determined by the ratio between the dynamic equivalent load (P_r) and the base dynamic load of the bearing (C_r , calculated according to ISO 281).

There are three main types of load according to this ratio:

i. **Small load**

$$P_r/C_r < 0.06; \text{ for } d < 100$$

$$P_r/C_r < 0.1; \text{ for } d > 100$$

ii. **Normal load**

$$P_r/C_r > 0.06; \text{ for } d < 60$$

$$0.06 < P_r/C_r < 0.12; \text{ for } d > 60$$

iii. **Heavy load**

$$P_r/C_r > 0.06; \text{ for } d < 60$$

$$P_r/C_r > 0.12; \text{ for } d > 60$$

Table 3.2

Operating conditions	Examples	Shaft diameter [mm]			
		Ball bearings	Cylindrical needle and tapered roller bearings	Spherical roller bearings	Tolerance class symbol
Radial bearings with cylindrical bore					
Stationary load on the inner ring					
Easy axial displacement of inner ring on shaft desirable	Wheels on non-rotating shafts (free wheels)	All diameters			g6 (f6)
Axial displacement of inner ring on shaft not necessary	Tension pulleys, sheaves				h6
Rotating inner ring load					
Light and variable loads ($P < 0,06C$)	Conveyers, lightly loaded mechanisms bearings	18÷100	≤40		j6
		>100÷140	>40÷100		k6
Normal and heavy loads ($P > 0,06C$)	General mechanical engineering electric motors, turbines, pumps, gearboxes, woodworking machine	≤18	-	-	j5
		> 18÷100	≤40	≤40	k5(k6)
		>100÷140	>40÷100	>40÷65	m5(m6)
		>140÷200	>100÷140	>65÷100	m6
		>200÷280	>140÷200	>100÷140	n6
		-	>200÷400	>140÷280	p6
		-	-	>280÷500	r6
Heavy loads and shock loads, arduous working conditions ($P > 0,12C$)	Heavy duty railway vehicles axle bearings, traction motors, rolling mills	-	>50÷140	>50÷100	n6
		-	>140÷200	>100÷200	p6
		-	>200	>200	r6
High running accuracy, light loads ($P < 0,06C$)	Machine tools	≤18	-	-	h5
		> 18÷100	≤40	-	j5
		>100÷200	>40÷140	-	k5
		-	>140÷200	-	m5
Axial loads					
	All kind of bearing application	≤250	≤250	<250	j6
		>250	>250	>250	js6
Tapered bore bearings with withdrawal or adapter sleeve					
	Axle shaft for railway vehicles	All diameters			h9
	General mechanical engineering				h10
Thrust bearings					
Axial loads					
Thrust ball bearings		All sizes			h6
Cylindrical and needle roller thrust bearings		All sizes			h6(h8)
Cylindrical, needle roller and cage thrust assembly		All sizes			h8
Combined loads spherical roller thrust bearings					
Stationary load on shaft washer		≤250			j6
		>250			js6
Rotating load on shaft washer or undetermined load direction		≤200			k6
		> 200÷400			m6
		>400			n8

3.2. Selecting the bearing fits

Bearing fits are selected on the basis of the following criteria:

- firm location and uniform support of bearings;
- simply mounting and dismounting;
- axial displacement of non-locating bearing.

According as the operation conditions, between the inner ring and the shaft, between the outer ring and the housing, respectively clearance fits, intermediate fits or interference fits may be performed.

When selecting the fit, one has to consider the difference of temperature which may occur between ring and shaft or between ring and housing. The tolerance classes are available for bearing fits which do not exceed +120°C during operation.

A high tightening is recommended for roller bearings and large size bearings in comparison to ball bearings of the same size. In case of a tight fit, the inner ring is supported by the entire shaft contact surface, thus bearing is used at full load carrying capacity.

When selecting a fit, the load of the rotating ring has to be considered and it will be avoided the excessive clearances or tightening. The excessive tightening couldn't eliminate only the radial mounting clearance of the bearing itself but can determine even the destruction of the ring in the mounting process (because of the tensions stress that are resulting from the ring).

At their turn, the excessive clearances may determine the reduction of the ensemble rigidity and the occurrence of the contact corrosion phenomenon due to the excessive mobility of the joint.

3.2.1. Tolerance classes for shafts

Table 3.2 recommends the selection of the tolerance classes for the shaft according to the bearing type, loading mode and shaft diameter.





3.2.2. Tolerance classes for housing bores

Table 3.4. recommends the selection of the housing tolerance classes.

Surfaces roughness of shaft and housing seating are given in table 3.5.

If bearings are mounted with adapter or withdrawal sleeves, shaft surface roughness should be of maximum $R_a = 1,6 \mu\text{m}$.

Table 3.3

Tolerance name	Fit	Symbol of deviation	Allowed deviations depending on the tolerance					
				P0 P6X	P6	P5	P4 (SP)	P2 (UP)
Tolerance of dimension	shaft		-	IT6(IT5)	IT5	IT4	IT4	IT3
	housing		IT7(IT6)	IT6	IT5	IT4	IT4	
Tolerance of roundness and cylindricity	shaft		t, t_1	IT4/2 (IT3/2)	IT3/2 (IT2/2)	IT2/2	IT1/2	IT0/2
	housing		t, t_1	IT5/2 (IT4/2)	IT4/2 (IT2/2)			
Tolerance of face runout	shaft		t_2	IT4(IT3)	IT3(IT2)	IT2	IT1	IT0
	housing			IT5(IT4)	IT4(IT3)	IT3	IT2	IT1
Tolerance of concentricity	shaft		t_3	IT5	IT4	IT4	IT3	IT3
	housing			IT6	IT5	IT5	IT4	IT3
Tolerance of angularity	shaft		t_4	IT7/2	IT6/2	IT4/2	IT3/2	IT2/2

Remarks: In case of bearings on which adapter or withdrawal sleeves are to be mounted, the shaft tolerances for deviations of form and position should be to IT5/2 tolerance class for shafts with diameter tolerance h9, and IT7/2 for shaft tolerance h10

3.2.3. Special fits for some types of bearings

In certain cases the selection of optimum fits for a bearing must be given up. Between these cases there is the design of mechanisms devices which during exploitation must be often dismantled to remove the bearings from their mounting places. For devices of cheap and low-importance machines for which it is not economical to process precisely and complexly the mounting places on the shaft, bearing tight fits will not be used. The same recommendation goes for shafts whose life is much longer than the one of mounted bearings and their frequent replacement would lead to an unavoidable wear of the spindles.

Table 3.4

Operating conditions	Examples	Tolerance class symbol	Remarks	
Radial bearings				
Solid housing				
Heavy loads on bearings in twin walled housings, heavy shock loads ($P > 0,12C$)	Roller bearing wheel hubs, connecting rod bearing	P7	Outer ring cannot be displaced	
Normal and heavy loads ($P > 0,06C$)	Ball bearing wheel hubs, connecting rod bearings, crane traveling wheels	N7		
Light and variable loads ($P \leq 0,06C$)	Conveyer rollers, rope sheaves, belt tension pulleys	M7		
Direction of load indeterminate				
Heavy shock loads	Traction motors	M7	Outer ring cannot be displaced	
Normal and heavy loads ($P > 0,06C$). Outer ring displacement is not necessary	Electric motors, pumps, crankshafts main bearings	K7		
Split or solid housings				
Direction of load indeterminate				
Light and normal loads. Desirable outer ring displacement. ($P \leq 0,12C$)	Medium sized electric motors, pumps, crankshafts main bearings	J7	Outer ring can be displaced	
Stationary outer ring load				
Any type of loads	General mechanical railway axle boxes	H7	Outer ring can be easily displaced	
Light and normal loads with simple conditions ($P \leq 0,12C$)	Gearing	H8		
Heat conduction through shaft	Drying cylinders, large electric machines with spherical roller bearings	G7		
Split housings				
High stiffness at variable loads	Main shafts for machine tools with roller bearings	$D \leq 125$	M6	Outer ring cannot be displaced
		$D > 125$	N6	
Light loads, indeterminate direction load	Shaft operating surface for grinding machines with ball bearings, free bearings for high speed superchargers	K6	Outer ring cannot be displaced	
Desirable outer ring displacement	Shaft operating surface for grinding machines with ball bearings, free bearings for high speed superchargers	J6	Outer ring can be displaced	
Quiet running	Small-sized electrical machines	H6	Outer ring can be easily displaced	
Operating conditions		Tolerance class symbol	Remarks	
Thrust bearings				
Axial load				
Thrust ball bearings		H8	For less accurate bearing arrangements, clearance in housing can be up to 0,001D	
Cylindrical and needle roller thrust bearings		H7 (H9)		
Combined loads on spherical roller thrust bearings				
Local load on housing washer		H7(H9)		
Peripheral load on housing washer		M7		
Axial or combined spherical roller thrust bearings				
Bearing radial location is ensured by another bearing		-	Housing washer fitted with clearance up to 0,001D	

In all these cases it is rational to use larger clearance fits than the theoretical ones namely less tightening fits and to avoid the rings rotation from the mounting places are used pins, keys or other fixing devices.

Normal precision bearings are usually used and only in a few special cases will be used enlarged precision bearings, for example in bearings of main shafts of grinding machines or of high precision lathes and for bearings of high rotation speed shafts where it is required to limit the centrifugal forces resulted from the rotation of the non-balanced elements and in electric motors. In case of using high precision class bearings, the shafts and housings must have a rigid construction and their processing accuracy must be at the level of bearing precision. Form deviations of shafts and housing bores will be two or three classes more accurate than the deviations mentioned for normal precision bearings. Thus, for high precision bearings (P5 or higher), used for machine tools, the housing bore will have to have K6 dimensional deviations and IT3 form deviations.

In the case in which the bearing bore is tapered, the tolerance of the form deviation of the housing bore will be smaller, respective IT2. Often it is recommended the dynamic balancing of the shafts.

Since in the mounting process the bearing rings shape up according to the part form on which these are mounted, it is useless and non-economic to recommend high precision bearings be mounted on the shafts and housings with major form deviations.

Table 3.5

Bearings. Tolerance class	Shaft.			Housing.		
	Diameter d, mm			Diameter D, mm		
	≤ 80	>80...500	> 500	≤ 80	> 80... 500	> 500
	Roughness R _a , [μm].					
P0, P6X and P6	0,8 (N6)	1,6 (N7)	3,2 (N8)	0,8 (N6)	1,6 (N7)	3,2 (N8)
P5, SP and P4	0,4 (N5)	0,8 (N6)	1,6 (N7)	0,8 (N6)	1,6 (N7)	1,6 (N7)
P2 and UP	0,2 (N4)	0,4 (N5)	0,8 (N6)	0,4 (N5)	0,8 (N6)	0,8 (N6)
<i>The roughness of the mounting surfaces of the shaft and housing</i>						

3.3. Bearing sealing

The correct sealing systems ensure a normal operation life to bearings and even the operation of the entire mechanism by their protection against penetration into the bearing of injurious elements (dust, material particles, humidity, acids etc.) and by keeping the lubricant inside the bearing.

In the assemblies with faulty sealing devices or devoid of sealing devices, different foreign bodies penetrate inside the bearing thus inducing an abrasive internal wear of the bearings or the corrosion of their active surfaces.

The leakage of the lubricant from the bearing during its operation determines a useless consumption of lubricants and if the lubricant leak is not discovered in time, it may result a fast heating and/or bearing damage.

The selection of the sealing system depends on the following factors, that feature the assembly operating conditions:

- a. bearing rotation speed;
- b. type of employed lubricant;
- c. lubricating system;
- d. assembly operating temperature;
- e. environmental conditions;
- f. constructive peculiarities of bearing assembly

From a functional and constructive viewpoint, the sealing systems are as follows:

- *Stationary seals*, between the stationary elements (housing and cover);
- *Rotary seals*, between the rotating bearing elements;
- *Non-rubbing seals*;
- *Rubbing seals*.

According to the working conditions, the environment in which the lubricated bearing operates, combined (special) sealing system can be used with both types of sealing at the same time. In their description we assume that the inner bearing ring rotates and the outer ring one is fixed.

3.3.1. Stationary seals

The simplest sealing used in bearings are spring washers (shields). This type of sealing is used for peripheral speeds up to 6 m/s in clean and dry environments and their efficiency depends on the clearance between the washer and the shaft in rotation, the housing, respectively or on the radial clearance of the bearing. For this reason, the check washers can be used for bearings with minimal radial clearance. When spring washer

is to be mounted, must be ensured their perfect contact on all circumferences of contact surfaces with the shaft (or housing) and bearing.

Figure 3.1a illustrates the sealing with stationary spring washers (stationary shields) which are used for consistent greases, figure 3.1b illustrates the sealing with rotary spring washers (rotary shields) used for liquid lubricants used onto bearings by centrifugal forces. In the same time the shields laterally shake the dust particles and other impurities from them.

Figure 3.2 presents two examples of bearings sealed with sealing washers type 2RS (2RSR) - figure 3.2a, or shielded bearings with shields 2Z (2ZR) - fig 3.2b, which are delivered together with the entire required grease content for their life and can be successfully operate.

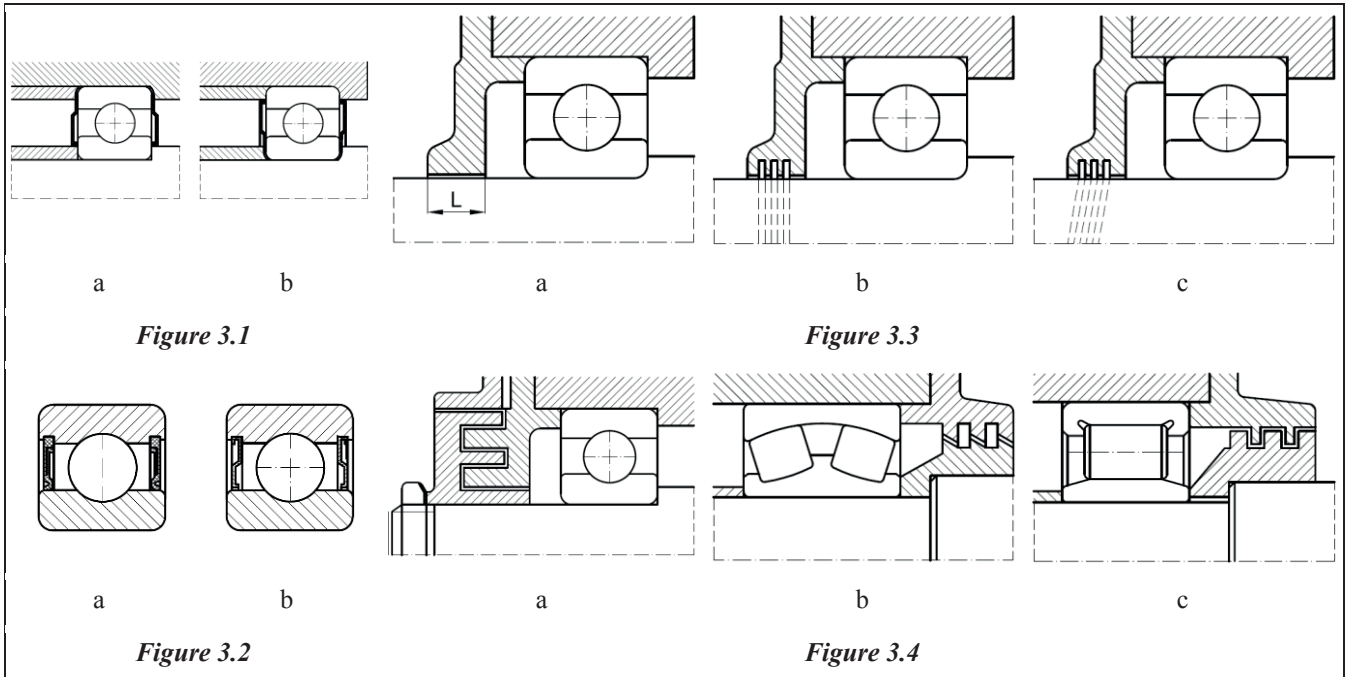

3.3.2. Rotary seals

3.3.2.1. Non-rubbing seals

This type of sealing is used for high temperature and speeds assemblies, their life being considered almost unlimited. There are the following types of rotary non-rubbing seals: gap seals, labyrinths and their combinations.

3.3.2.1.1. Gap rotary non-rubbing seals

They are used for assemblies less exposed to the danger of impurities and humidity penetration in the working space of the bearing.

In simple cases there are enough the gap seals presented in figure 3.3a, which are mainly designed to retain grease into the bearing housing. The efficiency of sealing is conditioned by the gap length and by the clearance between shaft (or housing) and the sealing element. Sealing can be improved if on the shaft or in the housing there are one or more circular grooves which are to be filled with grease (see figure 3.3b), so the leak of grease is reduced and is stopped the penetration of impurities.

In case of oil lubrication, the grooves on the shaft must be helical (figure 3.3c), and their direction must be the same with the direction of the shaft rotary movement. The allowable peripheral speed for this type of sealing is up to 5 m/s. During operation, the sealing grooves are maintained filled with clean, consistent and good quality grease.

3.3.2.1.2. Labyrinth seals

They are used at high peripheral speeds for the bearings that are functioning in environments with impurities, for example in dust or when the housing is water sprinkled. These are presented in figure 3.4.

By increasing the number of gaps the efficiency grows very much. The gaps inside the labyrinths must be filled with a grease based on calcium or lithium soap to ensure the anticorrosive protection in the presence of water. In difficult cases it is recommended from time to time (2...3 times a week) to press in the gaps fresh

grease to replace the dirty one or to complete the leakage. The labyrinths can be axially (a), radially (c), oriented or may have sloped steps (b). Sealing efficiency increases where both radial and axial labyrinths are used and the number of gaps is increased.

Other types of seals may be executed according to figure 3.5 through joining iron sheet blades (figure 3.5a) or processing the labyrinth walls with arc of circle form to avoid grease expulsion from the gaps in the housing in which the shaft is tilted (figure 3.5b).

Also in order to avoid this phenomenon (which is frequent in the case of high speeds), the radial runout of the surfaces that make the gap must be minimum and their roughness must be $Ra > 1.25 \mu\text{m}$.

3.3.2.2. Rubbing seals

When selecting the proper rotary rubbing seal the following factors have to be considered: material and its elasticity (felt, rubber, plastic materials, leather, graphite, asbestos, metals etc.), resistance at different temperatures, maximum peripheral speed on sealing surface, sealing direction etc.

The contact surfaces with rubbing seals must have a very small roughness especially when the peripheral speeds of the contact surfaces are very high.. It must be also assured a mounting that will not damage the sealing elements.

Figures 3.6a and 3.6b illustrate sealing with single or double felt rings frequently used for grease or mineral oil lubrication; these are constructively simple, cheap and recommended mainly for peripheral speeds between 4 and 7 m/s (provided the contact surfaces are bright finished) and temperatures over $+100^{\circ}\text{C}$, efficiently protect the bearing and prevent the leakage of the lubricant.

Before mounting, felt ring is impregnated during an hour with a mixture of mineral oil (66%) and paraffin (33%) at a temperature of $+70..+90^{\circ}\text{C}$, so that sealing is improved as the friction is reduced. The efficiency of felt sealing depends mainly on the felt quality (with long fibers). The use of low quality felt leads not only to its frequent replacement but can damage the bearing.

Figures 3.6c and 3.6e, illustrates rubbing seals with a spring incorporated, which are made of synthetic rubber or special plastic materials and have, in most cases, a metallic hardening fixture.

To maintain as long as possible a tightening force of the seal lip, around the felt ring is mounted a spiral spring. To press the seal in the housing it is recommended to use the press and to avoid the seal lip deterioration.

Rubbing seals with a spring incorporated are most suitable to be used in case of oil lubricated bearings which are operated under peripheral speeds of 5..10 m/s and temperatures between $-40^{\circ}\text{C}..+120^{\circ}\text{C}$.

Lubricant outflow can be stopped by mounting the rubbing seal with incorporated spring with the edge inwards (figure 3.6c) or outwards (figure 3.6e) if sealing has to prevent dust or other impurities from penetrating into the bearing.

Double sealing with these rubbing seals can also be used, improving thus the reliability and durability of the sealing.

In figure 3.6e, and f, we are presenting V-rings sealing (figure 3.6f) for grease lubrication and 3.6e for oil lubrication). V-ring seals are used at temperatures of $-40^{\circ}\text{C}..+100^{\circ}\text{C}$, roughness of sealing surface being $Ra=1,5 - 3 \mu\text{m}$.

V-ring seals can also be used on the shaft subject to eccentric or angular ($2 \dots 3$)^o movements.

For peripheral speeds up to 15 m/s the V-ring seal operates as a rubbing seal and for peripheral speeds over 15 m/s the seal lip will lift from the sealing surface operating as a centrifugal sealing.

To obtain superior sealing results, the above mentioned sealing are to be combined, example in figure 3.7a and 3.7b, or other combined sealing, thus ensuring good sealing for any operating conditions of the bearings assemblies.

The sealing systems for vertical shafts are not generally different from the systems used for horizontal shafts except lower bearings of the vertical shafts that require a special device to prevent lubricant leakage.

The presented sealing systems does not represents all the constructive possibilities.

The dimensions indicated for grooves and clearances at the labyrinth sealing (which have a great importance for the normal operation of the bearing) are recommended for the normal functioning temperatures.

In case of significant temperature variations and for high axial loads acting on the bearing, these dimensions must be increased.

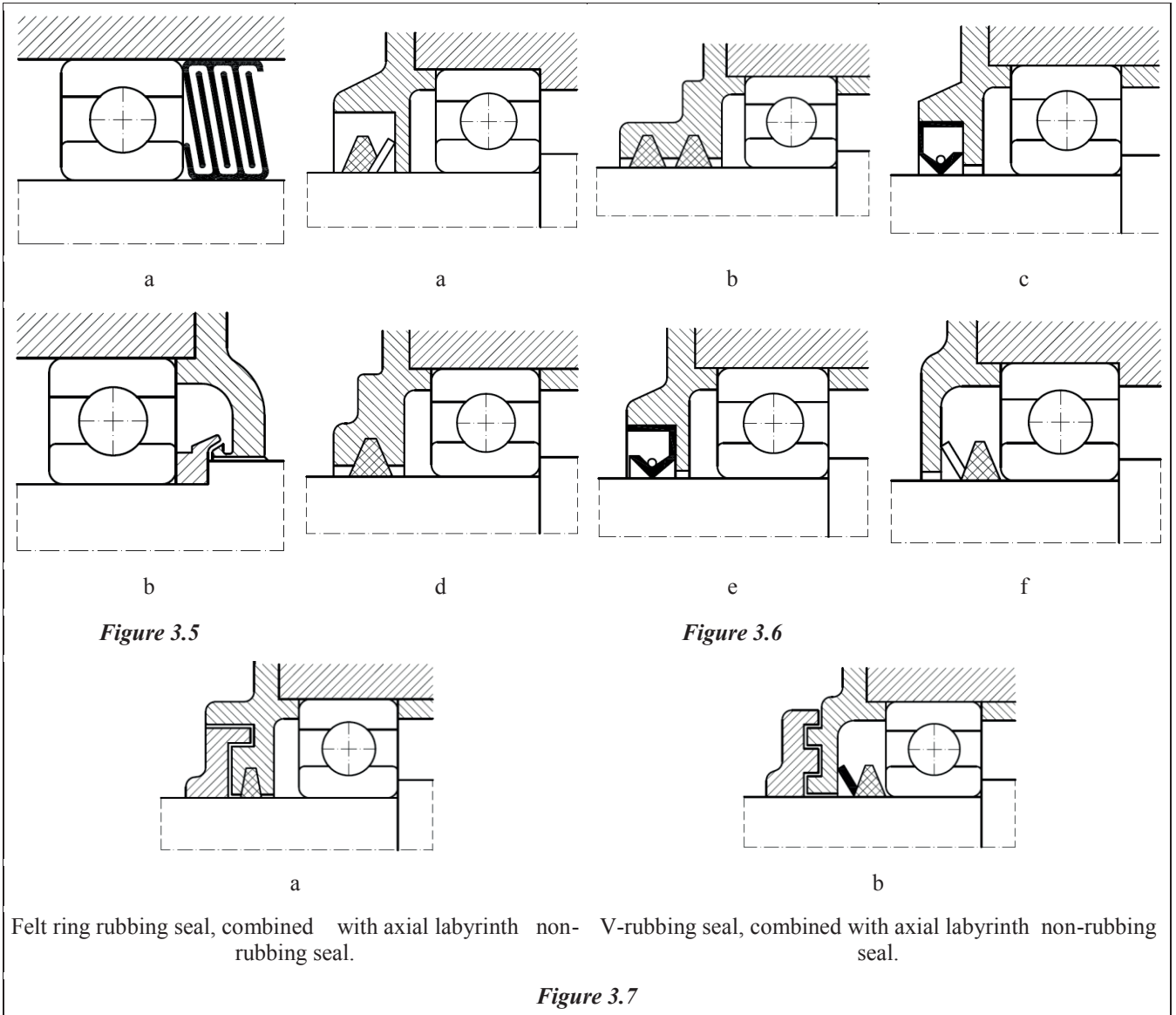

4. BEARINGS LUBRICATION

4.1. Lubricant selection

Liquid lubricants (mineral or synthetic oils), *consistent lubricants* (greases) or *solid lubricants* (graphite, molybdenum disulphide, teflon) are used in bearings lubrication.

Liquid lubricants usually exhibit some advantages, that ensure their priority in lubrication system selection for the following reasons: they have a greater stability than the consistent ones, could be used for high and low rotation speeds and temperatures, provide the evacuation of the heat produced within the bearing, are less resistant to rolling elements motions (which allows their use for precise and sensible devices), allow the replacement of the lubricant without dismounting the assembly, have the possibility to dosage the lubricant.

The main drawback of liquid lubrication is that the sealing housing is more difficult and requires a permanent check of the lubricant level..

The greases have the following advantages: a simple construction of the housing, safer and cheaper sealing, a better protection of bearings against external hazards and little danger of grease leakage than the liquid lubrication.

The lubricant selection is conducted both on the basis of the analysis of the operation conditions and of the properties of the lubricant because there are no universal lubrication systems. At the lubricant selection and for establishing the relubrication intervals, the following factors are to be taken into account:

- the size of the roller bearing
- the loading of the roller bearing
- the temperature of the roller bearing.

Thus, in the table 4.1 there are given some examples for the selection of the lubricant and relubrication intervals taking into account the above mentioned influence factors.

In order to solve by comparison the cases that there are not mentioned in the table above, the numbers mark the intervals for the factors that comply with the maintenance requirements and influence the lubricant selection. Conventional symbols in lubricants were also established: in case of oils, according to their viscosity and operating temperatures specified in table 4.2 and for greases according to their operating temperatures range and thickening agent (soap) specified in table 4.3

The determinant factors in lubricants selection and the assigned symbols in table 4.1 are:

a. *The size of bearing - (outer diameter) – dimension D*, in mm:

- 1 - for bearings with $D \leq 22$ mm
- 2 - for bearings with $22 < D \leq 62$ mm
- 3 - for bearings with $62 < D \leq 240$ mm
- 4 - for bearings with $D > 240$ mm

The influence of bearing size on the lubricant selection, through the examples given in the table 4.1, can be summarized as follows:

- for small roller bearings, especially at high rotation speeds, it is preferable that a low viscosity oil lubrication or a quality grease to reduce the friction;
- for large size bearings, the value of the friction force can be neglected in regard to heavy loads, so there can be used greater viscosity lubricants.

b. *The bearing rotation speed - n*, in rpm:

- 1 - for $n \leq 0,8 n_{lim}$
- 2 - for $n > 0,8 n_{lim}$, where:
 n_{lim} represents the limit rotation speed of the bearing given in the catalogue.

The value of the bearing rotation speed leads to a operation temperature increase. The greater the lubricant viscosity, the greater the value of the internal friction is. In the same time, the viscosity of the lubricant decreases with the increase of the bearing temperature. Irrespective of the viscosity value, the lubricating qualities must be preserved.

Another lubricants and cooling system selection criterion, takes into account the product $d_m \cdot n$ [mm·rpm], where d_m represents the mean diameter of the bearing. According to the table 4.4 there could be considered six utilization domains.

In case of very high rotation speeds that are exceeding n_{lim} mentioned in the catalogue, oil lubrication is required to evacuate the heat.

As a general conclusion, the increase of the rotation speed requires the decrease of the lubricant viscosity. In figure 2.4 there are presented recommendations for kinematic viscosity selection of the lubricant according to mean diameter (d_m) and bearing rotation speed (n).

Table 4.1

Application	Operating conditions						Relubrication interval	Remarks
	D	n	F	t	Grease	Oil		
Vehicles								
Wheels	2	1	1	1	2a	-	30000-50000 km	Gear oil
Crankshaft	2	1	1	2	-	1b, 2	15000-20000 km	
Gear boxes	2	1	1	3	-	2, 3	15000-20000 km	
Differentials	2	1	2	2	-	2, 3	15000-20000 km	
Clutch	3	2	1	3	2b, 2c, 3	-	Without relubrication	
Electric motors								
Household motors	1	1	1	1	2a		Without relubrication	Gear oil
Medium size	2-3	1	1	1	2a		1000-2000 hours	
Large size	4	1	1	2	3		500-1000 hours	
Traction motors	3	2	1	3	2c, 3		200000-500000 km	
Agricultural machines								
Soil machines	2-3	1	2	1	1a, 2b, 3		1000 hours	Gear oil
Food choppers	2	1	1	1	1a, 2b, 3		5000 hours	
Railroad stock								
Barrow axles	3	1	1	1	2a		10000-15000 km	1-2 years
Trolley car axles	3	1	1	1	2a		30000-100000 km	1-2 years
Passenger and freight carrier axles	3	1	1	1	2a		200000-400000 km	3-4 years
Ore or slag carrier axles	3-4	1	1	1	2a		100000-200000 km	2-3 years
Motorailers	3		1	1	2a, 3		200000-300000 km	2-3 years
Bloom buggies	3-4	1	1	1	2a, 3		-	3-4 years
High-speed locomotives	4	1	1	2-3	2a, 3		300000-400000 km	1-2 years
Shunter locomotives	3-4	1	1	1	2a		40000-60000 km	2-3 years
Mine locomotives	3	1	1	1	2a		40000-60000 km	1-2 years
Locomotives gear boxes	3-4	2	1	3-4				
Ship constructions								
Rudder bearings	3	2	2	3	-	3	4000-5000 hours	
Propeller bearings	4	1	1	1	-	2	8000-10000 hours	
Rudder mechanism	4	1	1	1	2a, 3	-	10000-15000 hours	
Wood-working machines								
Vertical mills	2	1	1	1	2a, 3		150-200 hours	
Horizontal mills	3	2	1	1	2a, 3		200-300 hours	
Planing machines	3	1	1	1	2a, 3		300-500 hours	
Saws	3	1	2	2	2a, 2b, 2c		2000-3000 hours	
Machine tools								
Main shaft of boring machines	2-4	2	1	1	-	1a	800-1500 hours	Eventually oil mist
Mills, lathes	2	2	1	1	-	1a	800-1500 hours	
Paper processing machines								
Wet parts	3-4	1	1	1	2a	-	2-3 months	
Dry parts	3-4	1	1	3	-	3	6-12 months	
Refiner	3-4	1	1	1	2a	-	6-12 months	
Calenders	4	1	1	2	-	1a	2-3 months	
Roll mills								
Gear boxes	4	2	1	2	-	2,3	500-1000 hours	Oil circulation
Conveyor rollers	3-4	1	1	2-3	2c	-		
Fans								
- small	2	1	1	1	3	-	No relubrication	Oil circulation
- medium	3	1	1	1	2	2	1000-1500 hours	
- large	4	1	1	1	-	2	3000-4000 hours	
Compressors	2	2	1	2	2a, c	-	500-1000 hours	
Centrifugal pumps	3	2	1	3	3	-	500-1000 hours	
Transport systems								
Cable wheels	1-3	1	2	1	3	-	No relubrication	Oil circulation
Conveyor idlers	2	1	1	1	3	-	2 years	
Drum shafts	4	1	1	1	3	-	4 weeks	
Crushers	4	1	2	1	3	2	1000-1500 hours	
Shaking screens	3	2	1	2	2a, 3	-	200-250 hours	
Shaking cylinders	3	2	2	3	-	3	200-500 hours	
Mixers	3-4	1	1	3	3	-	100-200 hours	
Rotating furnace rollers	4	1	2	1	3	-	1500 hours	Oil circulation or oil mist
Twisting machines	4	2	1	1	2a	-	2 months	

The significance of symbols is:

D - outer diameter; n - bearing operational rotation speed; F - bearing resultant load; t - operating temperature.

Table 4.2

Symbol	Freezing temperature t , ($^{\circ}\text{C}$)	Recommended viscosity, (m^2/s)
1a	$t < 50^{\circ}$	$(16-37) \cdot 10^{-6}$
1b	$t < 50^{\circ}$	$(11,8-60) \cdot 10^{-6}$
2	$50 \leq t < 80^{\circ}$	$(37-75,8) \cdot 10^{-6}$
3	$80 \leq t < 120^{\circ}$	$> 75,8 \cdot 10^{-6}$
4	$120 \leq t < 150^{\circ}$	$\approx 227,4 \cdot 10^{-6}$

Table 4.3

Symbol	Operating temperature range	Grease thickener	Water resistance
1a	$-35...+50^{\circ}$	Calcium	water repellent
1b	$-35...+50^{\circ}$	Calcium	water repellent
2a	$-30,..+80^{\circ}$	Natrium	unstable
2b	$-35...+120^{\circ}$	Natrium	unstable
2c	$-35...+120^{\circ}$	Natrium	unstable
3	$-25...+110^{\circ}$	Lithium	stable up to 90°C
4a	$< 60^{\circ}$	Calcium	for sealing
4b	$< 110^{\circ}$	Natrium	for sealing

Table 4.4

$d_m \cdot n$ [mm · rpm]	Lubricant type	Cooling system
< 50000	Any type of grease, including synthetic grease.	-
Over 50000 up to 150000	Mineral oil, non-synthetic grease.	-
Over 15000 up to 300000	Medium viscosity mineral oils and greases based on Calcium-Natrium soaps or Lithium soaps. It is not recommended any excess of grease in the housing not to determine the temperature rise.	-
Over 300000 up to 600000	Low viscosity mineral oil lubrication (oil feeding with a lubricator wick) or mist lubrication.	Cooling trough air flow (at the mist lubrication systems).
Over 600000 up to 1200000	Mineral oil pressurized lubrication with free flow or suction. For small bearings or light loads it is recommended oil mist lubrication.	Artificial cooling recommended.
Over 1200000	Mineral oil pressurized lubrication with free flow or suction. For small bearings or light loads it is recommended oil mist lubrication.	Artificial cooling.

Also, in the table 4.5 there are given the correspondences between the ISO viscosity classes and the kinematic viscosity at 40°C , in mm^2/s (cSt).

c. Bearing loading force, F , calculated with the relation:

$$F = X \cdot F_r + Y \cdot F_a, [N]$$

where: F_r is the radial load of the roller bearing, [N]

F_a is the axial load of the roller bearing, [N]

X, Y , correction factors according to the load, axial or radial (values according to the catalogue).

Thus, for the loading force are defined the following symbols:

- normal loading force, if the ratio $F/C \leq 0.1$ for 1, 2 and 3 width series and $F/C < 0.15$ for 4 width series, where C is the basic dynamic load rating of bearings according to the catalogue.
- high loading force, if the ratio $F/C > 0.1$ for 1, 2 and 3 width series and $F/C < 0.15$ for 4 width series.

The influence of the load size (bearings loading force) for grease lubrication can be expressed by the ratio $f \cdot (F/C)$ as shown in figure 4.1 plot. The f factor is experimentally established and has the following values: $f = 1$ for the ball bearings for any load and for the roller bearings when the radial load is predominantly, ($(F_a/F_r) \leq 1$);

$f = 2$ for roller bearings when the axial load is predominantly, ($(F_a/F_r) > 1$)

In figure 4.1 the grease group is determined according to the load and rotation speed. The domain is considered to be divided in three fields as follows:

- first field, I, delimited by $f \cdot (F/C) = 0.15$ and $n/n_{lim} = 1$. In the operating conditions that are according to this field may occur high temperatures and sometimes there are required high temperature greases;

- second field, II, corresponds to bearings subject to high loads and require the use of higher viscosity greases, having composite elements (EP-extreme pressure), that ensures their resistance to high pressures and good lubricating properties;

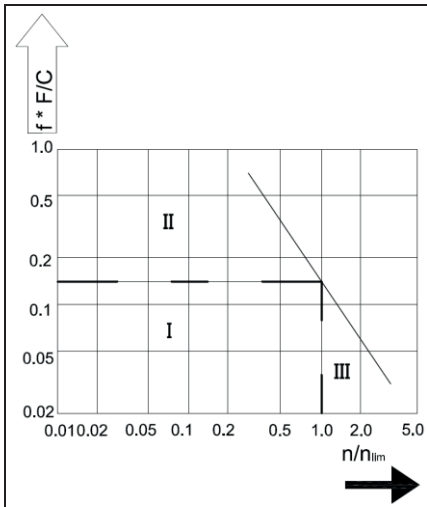

Figure 4.1

Bearing operating temperature, (°C)	Viscosity at 50°C	
	Centistokes (cSt)	Engler degrees, (°E)
30	7	1,52
40	8,5	1,70
50	12	2,06
60	17	2,65
70	25	3,65
80	35	4,96
90	50	6,96
100	70	9,67
>100	150...200	20...30

Table 4.6

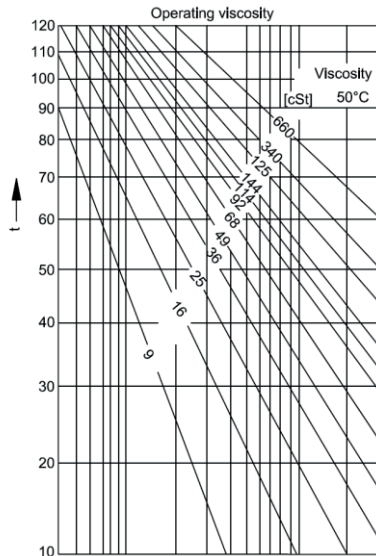
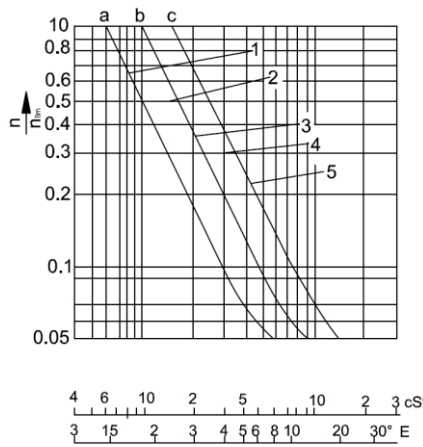

Figure 4.2

Viscosity class according to ISO	Kinematic viscosity at +40°C, mm ² /s (cSt)		
	mean	min	max
ISO VG 2	2,2	1,98	2,42
ISO VG 3	3,2	2,88	3,52
ISO VG 5	4,6	4,14	5,06
ISO VG 7	6,8	6,12	7,48
ISO VG 10	10	9	11
ISO VG 15	15	13,5	16,5
ISO VG 22	22	19,8	24,2
ISO VG 32	32	28,8	35,2
ISO VG 46	46	41,4	50,6
ISO VG 68	68	61,2	74,8
ISO VG 100	100	90	110
ISO VG 150	150	135	165
ISO VG 220	220	198	242
ISO VG 320	320	288	352
ISO VG 460	460	414	506
ISO VG 680	680	612	748
ISO VG 1000	1000	900	1100
ISO VG 1500	1500	1350	1650

Table 4.5

- third field, III, corresponds to bearings subject to high speeds and low loads. To provide the formation of a lubricant film it is important that the internal friction of the lubricant and the friction between the bearing elements are reduced. To prevent the centrifugal disposal of the grease at high speed, these must have a good adhesion characteristic. A good behavior has the greases based on lithium soap, complex soaps or with organic synthetic thickeners, and synthetic low viscosity base oils.

Also, for the mountings with sloped or vertical shafts, because of their own weight there is the danger for the grease to leave the roller bearing, mainly at high temperatures. Thus it is required the use of a good adhesion characteristic and high temperature greases.

The significance of domains and curves of figure 4.2 plot is:

- 1 - cylindrical roller bearings curve of radial loading;
- 2 - the domain of the deep groove, tapered and self-aligning ball bearings (a-radial loads, b-axial loads);
- 3 - the curve of the four-point contact bearings;
- 4 - the domain of tapered roller bearings, self-aligning roller bearings (curve b-radial loads, curve c-axial loads);
- 5 - the curve for the thrust ball bearings and self-aligning roller bearings.

d. Operating temperature, t ($^{\circ}\text{C}$), with the symbols:

1 - $0 \leq t \leq 50^{\circ}\text{C}$

2 - $50 \leq t \leq 80^{\circ}\text{C}$

3 - $80 \leq t < 120^{\circ}\text{C}$

4 - $t \geq 120^{\circ}\text{C}$

The bearing operating temperature is in most cases conditioned by the difference between the heat quantity produced during operation and the undesirable heat quantity carried away to other machine devices or under medium. The bearing operating temperature conditions the viscosity of the lubricant and imposes their features, because every lubricant has a temperature range in which this maintains its physical and chemical properties. (The operating temperature of a bearing is the temperature measured on the fixed ring).

4.2. Liquid lubricants

4.2.1. Selection of liquid lubricants

The sealing difficulties and lubricant leakage limit the applications of liquid lubrication to the applications where the stability and control of the lubricating film, reduced friction and cooling effects (heat evacuation through lubricant is determined by load, rotation speed and operating temperature) are important. Where the lubrication of bearings can be achieved in a common oil bath, liquid lubrication is recommended.

Liquid lubricants for the bearings are both mineral and synthetic oils and mixtures of mineral and synthetic oils. The oils can be added with solid lubricants (molybdenum disulphide, graphite, teflon) or with other substances whose action manifests positively in improving the resistance of the lubricating film under high load, in avoiding the oxidation, the froth or viscosity decreasing at the increase of the temperature, etc.

The oil viscosity is highly influenced by the temperature, decreasing at the increase of the temperature. The dependence of viscosity on temperature is evaluated by the viscosity index (IV), a higher value ($\text{IV} > 100$) indicates a better stability of viscosity related to temperature. Table 4.6 presents the recommendations for the choice of oil viscosity at 50°C according to the operating temperature of the bearings.

The viscosity is also influenced by pressure which is important mainly in the case of bearings, and for that reason in the case of special applications with heavier loaded bearings it is necessary to choose the lubricant after a thorough analysis.

The chart in figure 4.2 may be used to determinate the viscosity at 50°C (in cSt). The upper diagram serves for determining the oil viscosity according to the bearing type, to the type of the load, and to the ratio n/n_{lim} , where n represents the working rotation speed of the bearing and n_{lim} represents the limit rotation speed for oil lubrication (values according to the catalogue). As a general rule, the viscosity must be greater for the axially loaded bearings than for the radially loaded ones.

The lower diagram is used to establish the oil viscosity (in cSt at 50°C) according to the operating temperature, t [$^{\circ}\text{C}$], and viscosity.

Table 4.7

Circulating systems	Working conditions. Hints.	$d_m \cdot n$	Oil viscosity at 50°C (m^2/s)	Example in figure
Oil bath	The bearing is filled in oil to the middle of the lower rolling element for horizontal shafts and to 70 - 80% of the roller bearing width for the vertical shafts. Used for road vehicles, machine tools and railway vehicles. Magnetic plugs are recommended for catching the metallic particles. Attention to sealing and level check.	< 200000	$(12,5..180) \times 10^{-6}$	4.3, 4.4
Oil bath with external circulation	The oil is delivered with a pressure of 0,15 MPa from a central tank fitted with a cooling, heating and filtering and flow regulating system. The diameter of the evacuation pipe will be 2 .. 10 times greater than the one of the feeding pipe.	< 600000	$(30..120) \times 10^{-6}$	4.5
Oil jet	High loads and speeds where cooling is required. The diameter of the evacuation pipe is greater than those of the nozzle. The flow is set to 0,5 .. 10 l/min according to the temperature. Used for machine tools, axial compressors, centrifugal separators.	< 900000	$(15..50) \times 10^{-6}$	4.6, 4.7

Table 4.7(cont'd)

Circulating systems	Working conditions. Hints.	$d_m \cdot n$	Oil viscosity at 50°C (m ² /s)	Example in figure
Sprinkling (splashing)	Medium loads and rotation speeds. Used for vehicles, gear boxes. Magnetic plugs are recommended for catching the metallic particles.	< 175000	(20..90)x10 ⁻⁶	4.8
Oil driving	High speeds. The oil thrower ring must allow also oil mist formation.	< 180000	30x10 ⁻⁶	4.9
Oil drop	Medium loads and relatively high rotation speeds. Used for machine tools. The lubricant flow must be set at 0,5 .. 6 drops per minute.	< 210000	30x10 ⁻⁶	4.10
Oil mist	Medium and small bearings with high loads and rotation speeds. The required flow of oil mist is of (0,001 .. 5) cm ³ /hr. The pressure is of (0,05 - 0,5 MPa) and the air flow 0,5 - 4 m ³ /h.	< 1200000	(16,5..45)x10 ⁻⁶	4.11

4.2.2. Liquid lubricants circulating systems

For the usual lubrication of bearings very low quantities of lubricant are necessary to reach the lubricating film. Considering the fact that the oil is required to act as coolant, it must be taken into account this requirement when determining the lubricant quantity. Heat evacuation from the bearing through the lubricant is more necessary when load and rotation speed increases.

The oil circulating systems, regarding the way in which bearing lubrication is assured are achieved through the following: oil bath lubrication; oil bath with external oil circulation; jet lubrication; sprinkling by conveyance ring; oil driving by thrower ring; oil dropping; oil mist.

The selection of a lubrication system may be also done according to the recommendations given in table 4.7 that take into account the general working conditions and the product $d_m \cdot n$.

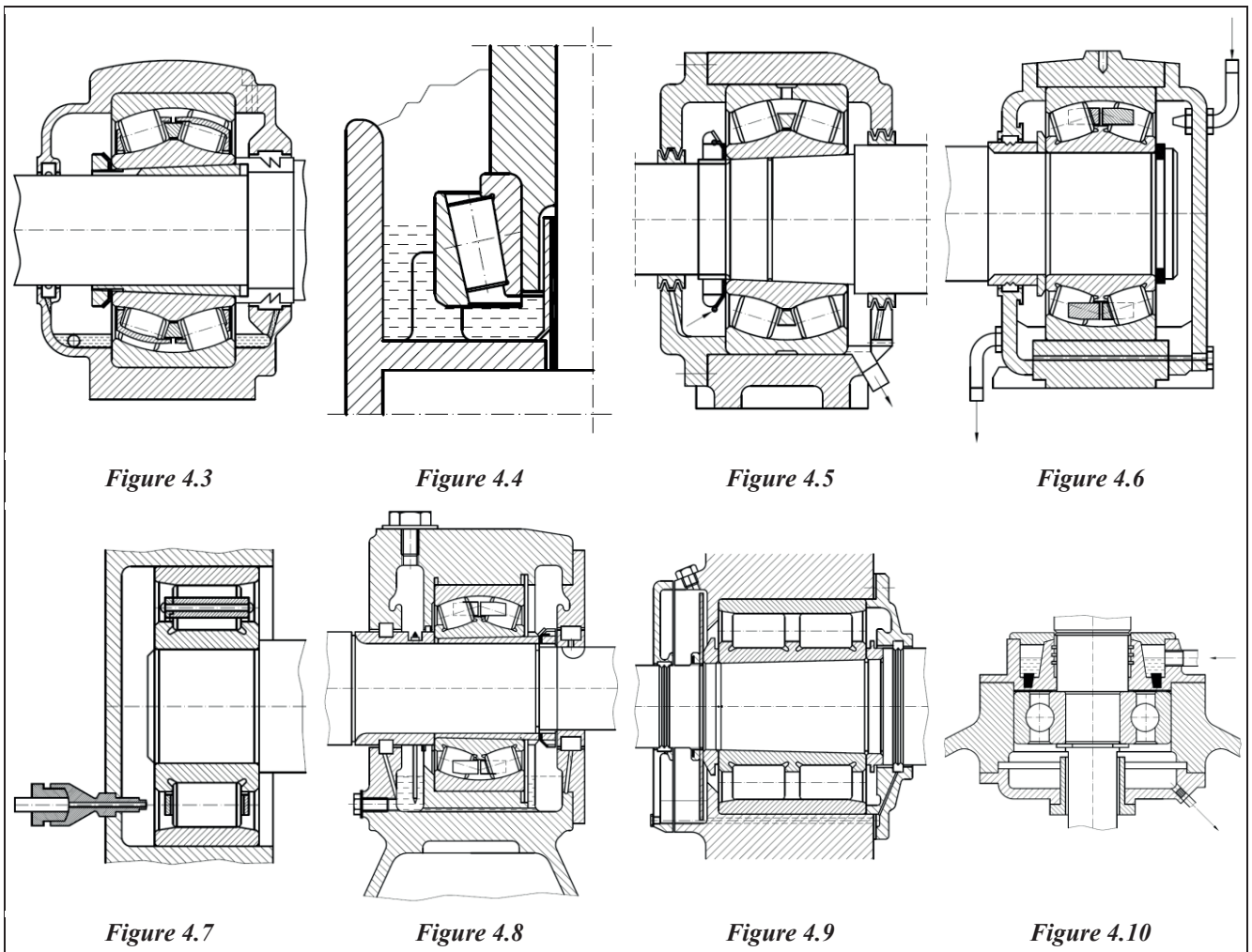

Figure 4.3

Figure 4.4

Figure 4.5

Figure 4.6

Figure 4.7

Figure 4.8

Figure 4.9

Figure 4.10

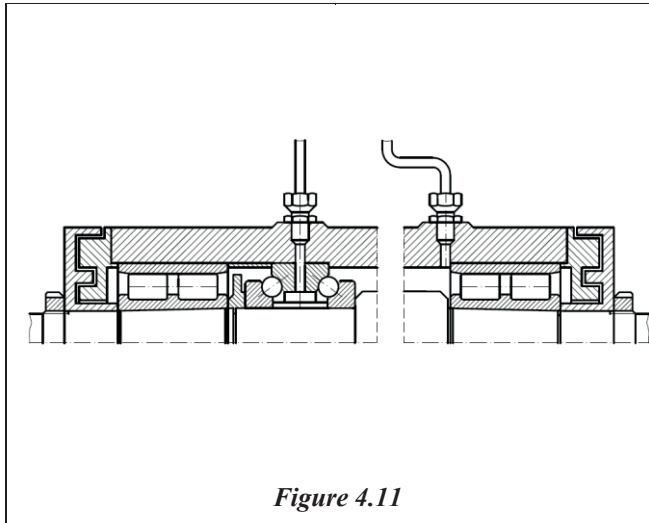

Figure 4.11

Bearing type	Value of coefficient α	
	Relubrication interval	Grease life
Spherical roller bearing	1	2
Tapered roller bearing	1	2
Thrust ball bearing	1	2
Cylindrical roller bearing	5	15
Needle roller bearing	5	15
Deep groove ball bearing	10	20-40*

Table 4.8

4.3. Consistent lubricants (greases)

4.3.1. Selection of consistent lubricants

Except the direct use of the vegetal or animal fats as lubricants in very restrained applications, greases represent the usually consistent lubricant because of the simple housing construction, simplicity of the sealing and the relubrication facility.

The greases are obtained as dispersed mixtures with plastic properties of some thickening agents as dispersed phase (soaps of the fatty acids of Na, Ca, Li, Pb etc or paraffin, bentonite, silica gel etc) in mineral or synthetic oils or in oleaginous fluids as dispersion environment (75 - 90 %). In grease composition may be introduced additives for high loads, corrosion avoiding or thermal stability.

4.3.2. Lubricant quantity and relubrication intervals

The amount of grease to be packed into the bearing at the beginning depends on the rotation speed. The bearing cavities should be filled with grease to capacity to ensure all the functional areas of the bearing are supplied with grease. The housing space should be filled as follows:

- full at $n/n_{lin} < 0.2$;
- one third at $n/n_{lin} = 0.2 \dots 0.8$;
- not at all at $n/n_{lin} > 0.8$ where n represents the working rotation speed and n_{lin} represents the limit rotation speed recommended for greasing in the catalogue.

The grease quantity required for the initial lubrication at the normal bearings can be calculated with the following relations:

$$G = d^{2.5}/900, [g], \text{ for } d \text{ in mm, at ball bearings;}$$

$$G = d^{3.5}/350, [g], \text{ for } d \text{ in mm, at roller bearings,}$$

where: d is bore diameter of bearing.

At high rotation speeds of the shaft it is recommendable that, before introducing grease in bearing, this must be immersed in refined mineral oil of mean viscosity, then, after oil release, to be introduced the grease.

In bearings with $n/n_{lin} = 0.2 \dots 0.8$ with horizontal axis it is indicated to fill only the lower half of the housing and the cover to remain empty. At vertical axis mountings in which the housing is made of two pieces is recommendable that both pieces are introduced into the grease but only to half of the free space.

For low rotation speed bearings ($n/n_{lin} < 0.2$) that are operating in moisture and dusted environment, the free space of the housing must be fully filled to obtain a satisfactory sealing.

Normally at the beginning of operation of a recently greased bearings, it may notice a temperature increase over the normal working temperature after which the temperature decreases and remains constant at a value of 10 - 50°C over the environment temperature. The persistence of high values of temperature may be due to an excess of grease within the bearing, a too heavy load on the bearing or to misalignment of shafts.

The relubrication intervals are established by practical observations and adequate recommendations or with experimentally established formulas such as:

$$T_u = \alpha \cdot \left(\frac{14 \cdot 10^6}{n \cdot \sqrt{d}} - 4 \cdot d \right) \cdot f_1 \cdot f_2 \cdot f_3$$

where:

- T_u - relubrication interval or the grease life, in operation hours;
- α - coefficient depending on the bearing type (see table 4.8);
- n - bearing rotation speed, rpm;
- d - bore diameter of the bearing, in mm;
- f_1, f_2, f_3 - coefficients depending on the operating and environmental conditions (see tables 4.9 and 4.10)

The values resulting from calculus without f_1, f_2, f_3 correction coefficients are valid for working temperatures up to 70°C.

For temperatures above this value the relubrication interval decreases to a half, than the preceding period, for every 15°C without exceeding the temperature limit for every type of grease. The relubrication interval is also reduced when there is not a good environmental condition for grease or in hard operating conditions. Where the grease has a sealing role against water penetration, (where the housing is frequently washed as for the paper processing machines) it is necessary to complete weekly the amount of grease.

For the replenishment, the required quantity is given by the guide formula:

$$T_c = K_c \cdot D \cdot B, [g]$$

where:

- D - outer diameter, in mm;
- B - roller bearing width, in mm;
- K_c - coefficient (table 4.11)

Replenishment must be done with the same type of grease or compatible ones to avoid the incompatible mixtures.

4.3.3. Consistent lubricants feeding systems

In an increasing no. of applications it is recommended the use of the greasing in bearings with protection devices (shields) or sealing devices (seals).

In conditions of a controlled technological process, the greasing enhances the behavior and durability of bearings. The grease is filled into the cavities in a ratio of 30 - 50%, according to the minimum quantity required for greasing, but also to the heat produced in the bearing and its evacuation in the exterior. Usually in this conditions the greasing is done once for the entire life of the bearing, named "life-time" lubrication.

For the rest of greased bearings constructions the best solution is given by the normal application of grease in the housing hollows (figure 4.12) in the above mentioned ratio. If the relubrication intervals are at least of 6 months, replenishment ducts or devices are not executed. Ribs may be executed on covers to reduce the grease rotation trend together with the shaft or bearing, or adequately dimensioned elements (adjusting washers) to prevent the filling of too much grease within the bearing (figure 4.13)

The grease replenishment must be done with grease cups, greasing pump ("grease gun") to insert grease under pressure or grease pump to introduce grease in the centralized greasing systems.

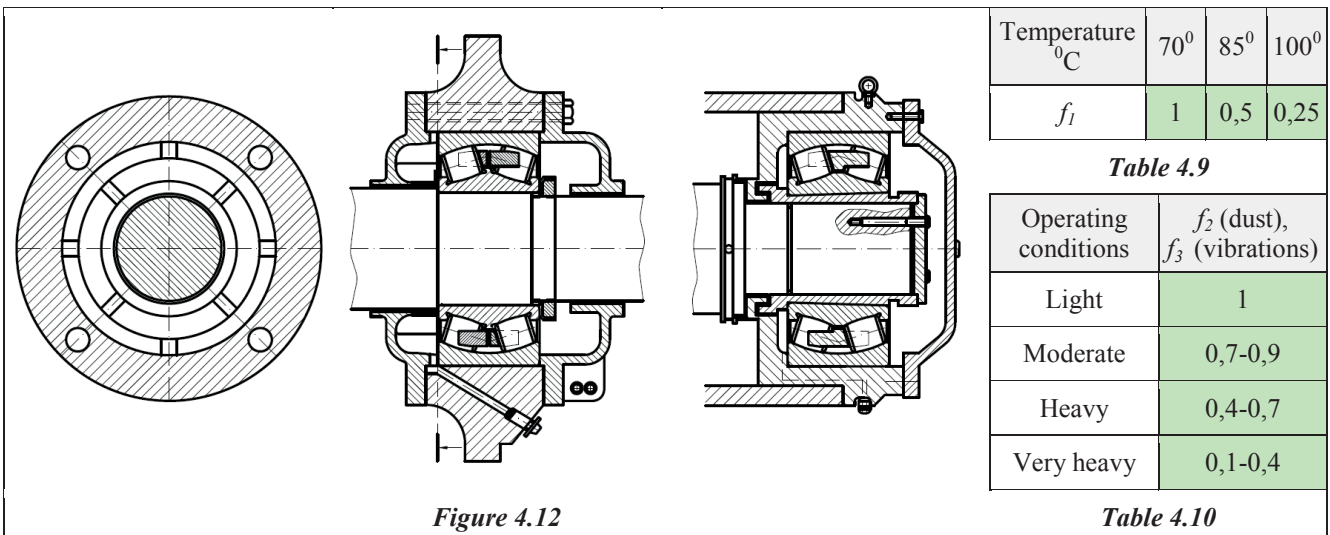

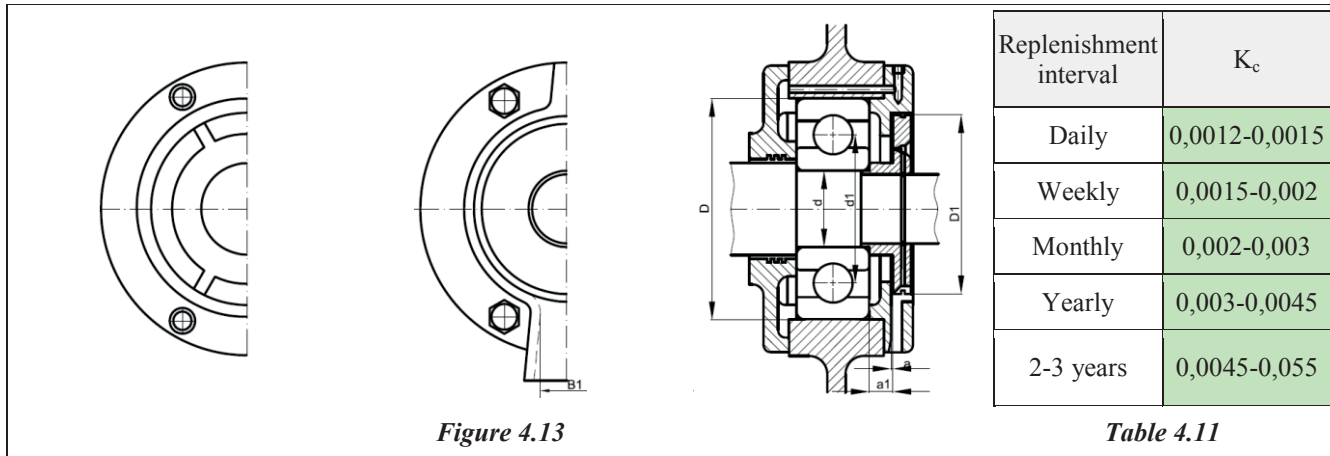

5. BEARINGS STORAGE AND HANDLING

Having in view the execution precision of bearings, an adequate storage, handling and a correctly executed mounting is required.

The bearings must be stored in the original packing, in clean rooms, protected against dust and volatile corrosive substance intrusion.

The relative humidity of the air inside the rooms must not exceed 60%, this being determined by means of a hygrometer and the optimal storage temperature is 18 - 20°C (maximum 25°C and minimum 15°C).

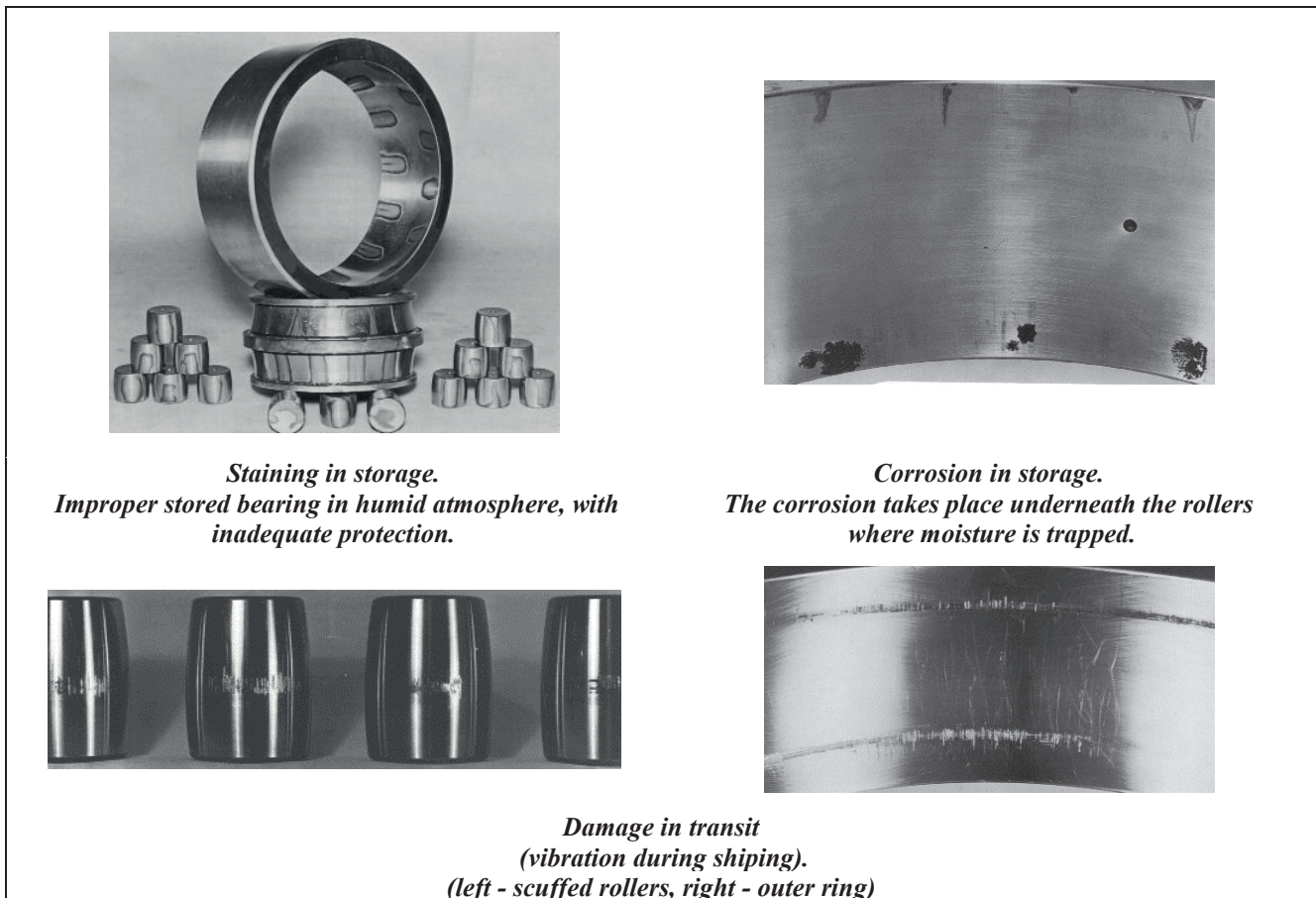

Bearing handling between storage and mounting will be done carefully in order to protect the original pack and avoid its deterioration. Falls from heights and chokes will be avoided because the bearing steels are quite sensitive to chokes.

In view of their storage, bearings will be stored on metallic or dry wood shelves (painted and covered with iron sheet) mounted at least 50 mm distance from the walls. It is not allowed to stack bearings so that they may come into contact with water, heating and air fan pipes with solar radiation or corrosive substances.

It is not recommended to store bearings directly on the floor.

The bearings unpacking must be done only at the beginning of the mounting operation. It is not allowed to handle them with wet hands because humidity and perspiration could determine corrosion phenomena.

It is recommended the wear of protective gloves or handling the roller bearing with a clean and dry piece of cloth.

6. MOUNTING OF BEARINGS

6.1. The preparation of components for the mounting procedure

Before mounting, all components must be verified according to the prescriptions at the dimensional, form precision and surface quality.

The composite elements that are specific to a bearing assembly are: shafts, housings, axial fixing elements (adapter sleeves, shafts and housings, covers) and sealing element.

6.1.1. The preparation of new bearings

Bearings in their original packing are protected against corrosion and it is not necessary to remove the preserving substance (oil or grease) from them.

Removing of the original packing will be done in the same day when the mounting of bearings is performed.

6.1.2. The preparation of used bearings

Bearings with damaged packing and bearings preserved more than 12 months will be washed and preserved again.

For cleaning, the bearing will be introduced in a lamp oil bath, clean diesel fuel or white-spirit to remove the old preserving substance and the other impurities.

During cleaning the rings must be rotated so that all surfaces are cleaned. After cleaning, the bearing must be immersed in another bath with white-spirit to rinse it and after that it will be dried suspended. Before rinsing, the aspect of the exterior surfaces of the bearing must be verified. If there are noticeable corrosion points with a surface less than 5 mm² on the external surfaces of the outer ring and on the frontal surfaces of both rings, it is allowed to remove them by friction with sandpaper.

It is strictly forbidden to effect this operation on the rolling sides of the bearing (race ways and rollers)!

For the anticorrosive protection of relubricated bearings, the best method is to insert them in a technical Vaseline (petroleum jelly) bath at 50-60°C or consistent grease heated at 70-90°C. After the complete heating of bearings (recognized by the uniform layer of grease on them), they must be removed from the bath, dried and after cooling, they will be packed in plastic sheet or waxed paper and will be stored in cardboard boxes (for small and medium size bearings) or wrapped in textile band (large size bearings).

The insertion and removal of bearings from the bath must be made with metallic hooks without touching the bearings bare-handed.

The grease or the technical Vaseline could be replaced with bearings preservation products.

To prevent the impurity contamination of greases bearings, the following directions must be respected:

- the bowl in which the grease is preserved must be closed with a lid;
- do not take out the grease with dirty hands or instruments.

It is recommended the use of a metallic shovel which can be easily cleaned.

In case the above mentioned directions are not respected, the premature damage of the bearings is facilitated.

6.1.3. Shafts preparation for bearings mounting

There are verified the mounting surfaces, including the frontal part of the shafts ribs which must be clean, smooth, without traces of impact, scores, corrosion etc.

The presence of abrasive particles or metal chips makes the mounting procedure extremely difficult.

If in spite of such shaft damage, a bearing is mounted on it, its position may be incorrect determining a decrease of its durability. If bearing is fixed in an axial location through a lock nut, it is necessary to screw up one time the lock nut to remove the bits that otherwise could reach the inner side of the bearing.

Dimensional precision check according to the execution drawings is done by fixing the axis between the bottoms or in rests with the aid of a limit gauge or with the micrometer. It is necessary to check the shaft diameter with the micrometer in several points situated on the length of the shaft (figure 6.1). This allow the observation of the processing uniformity on the entire length and points out the tapering of the shaft. The ovality of the shaft must also be checked by means of a micrometer or limit gauge in a few planes and at least in three direction at 120° for every plan. To verify shape deviations in case of long dimension spindles a straight line with ink on it is used. The line is placed on the shaft in longitudinal direction and after that is moved back and forth. If the shaft is straight, on its surface is formed a continuous band of ink and if the spindle has surface deviations the ink band will be interrupted.

To verify the small length taper shaft, a ring gauge covered with ink which allows shape deviation verification through the look of the ink deposits on the shaft surface is used.

At diameters greater than 140 mm the ring gauges are replaced by special measuring devices.

The lower dimensioned shafts **must not be admitted** in the mounting process because in this case the rotation of the inner ring is unsuitable. This phenomenon is accompanied by a fast increase of the bearing temperature determining its rapid destruction. Because of strong heating, the bearing will get dark and the surface of the shaft will be destroyed. This procedure must not be applied because the securing of the interior ring of the bearing against axial displacements does not exclude the danger of ring rotation on the shaft.

Neither over-dimensioned shafts must be admitted in mounting because of the dilatation of the inner ring leading to the disappearance of the radial clearance required in exploitation. If the clearance between the rings is reduced, the rollers or the balls will be blocked. Such a bearing will have a slow motion, it will be very heated and will be destroyed soon.

Thus, it is important to choose correctly and to respect the tolerance fields for shafts and the tolerances for form and position deviations.

For a normal functioning in bearings, especially in case of high axial efforts and high rotation speeds it is very important that the shaft ribs and connections be correctly designed and executed with maximum precision.

The frontal part of ribs must not have scratches of impact signs and damage because the ring of the bearing must adhere uniformly to the entire frontal surface. The shaft rib must be normal on the spindle axis.

The check of rib perpendicular alignment normality may be done with the gauge through shaft securing between its two sides.

If the ribs are not perpendicular alignment on the surfaces and shaft axis, these are determining additional stresses on the bearing even in the absence of the external loads.

The processing conditions required to the ribs are important for the bearings when the cylindrical roller is axially loaded or when the exterior ring must be pressed onto the housing.

In figure 6.2 it is illustrated an exaggerated case of deformation of the cylindrical roller bearing inner ring because of the incorrect processing of the rib shaft.

The shafts with tapered ribs will be rejected from mounting because in this case only the exterior or the interior side of the bearing can touch the frontal surface of the rib after the bearing mounting as illustrated in figure 6.3. and 6.4 Under high load, the rib will rapidly deform itself and the bearing will not be tight between the lock nut and the shaft rib.

The surfaces of the shaft in contact with the bearing will have the roughness Ra according to table 3.5.

When moved inside the workshops, the shafts will be protected with sleeves. The shafts prepared for utilization and from several reasons are to be kept stored for more time must be protected with a technical Vaseline or grease layer and then will be packed in waterproof paper.

6.1.4. The preparation of housing

Generally, the above mentioned hints for shaft preparation are valid for the housings and for any other pieces which are part of a bearing assembly.

The inside part of the housings is measured with fixed gauges or interior micrometers. The interior surfaces will be examined to be smooth, clean, without impurities, burrs without cracks, scores etc. The outer ring of the bearing mounted in its seat must be uniformly in contact on all its circumference which is possible only when the boring is precisely processed.

In case of two-piece housings it will be verified the finishing degree of the contact surfaces of the two pieces to secure a good adherence eliminating any clearance between them.

The scaling check of the two contact surfaces will be done with the thickness gauge which must not cross nowhere along the contact surface of the two halves.

Form (cylindrical, taper) deviation check will be done according to figure 6.5 through measurements effected in several planes and positions (1, 2, 3, 4) in at least 3 places on the circumference (diameters AA, BB, CC, DD), by turning the micrometer with 120° .

Alignment and parallelism of the half housings against their side surfaces can be verified through measurement of the thicknesses L1 and L2.

The correct geometrical form of the housings (even the one of the two pieces housings) is checked with gauges of adequate dimensions. These ones after their painting on the cylindrical surface are pressed onto the surface of the boring and rotated several times in both ways.

The surface of the housing bore is considered to be good if the paint tracks cover at least 75% of the surface. The surface of the housing bore will have a roughness Ra according to the table 3.5.

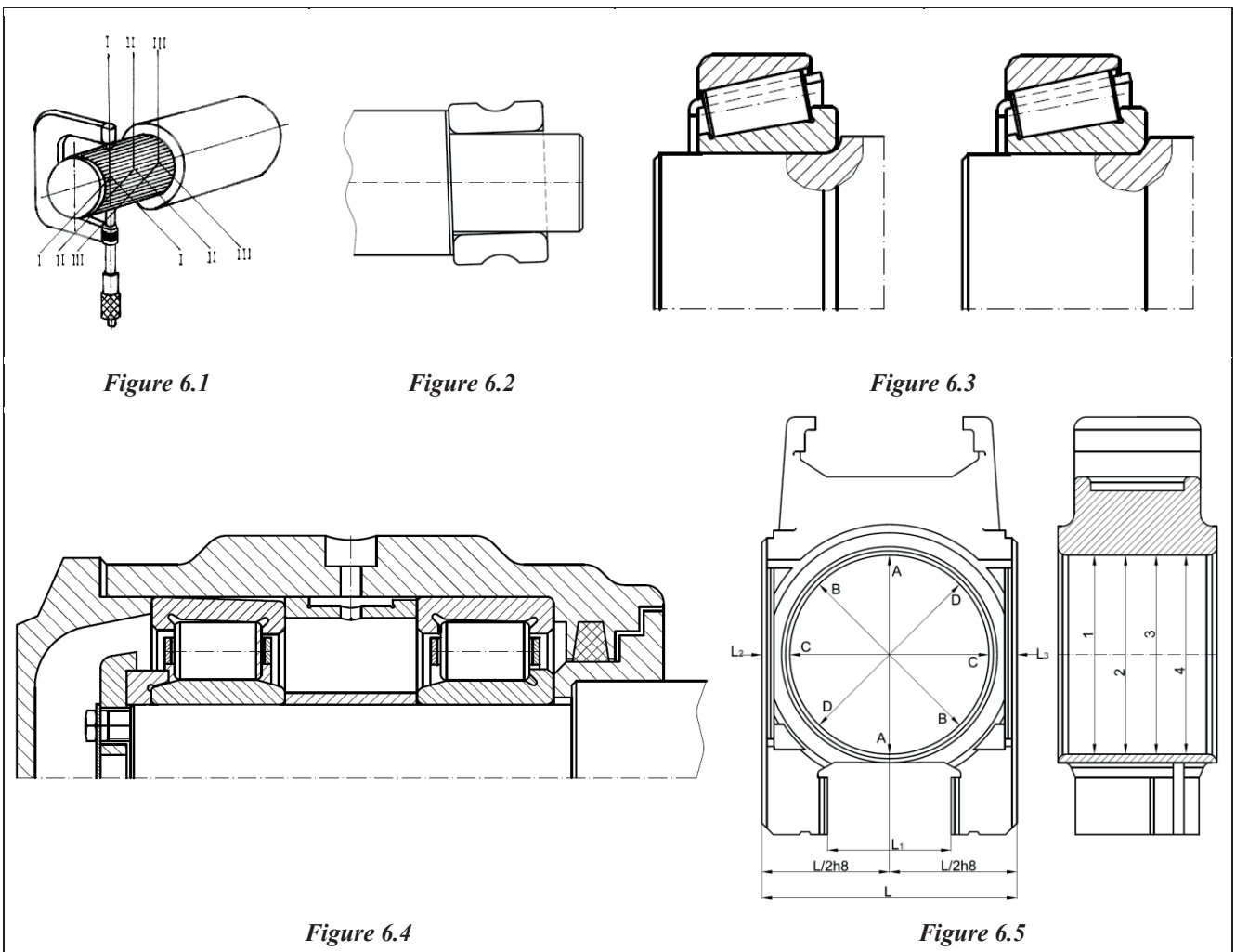

Figure 6.1

Figure 6.2

Figure 6.3

Figure 6.4

Figure 6.5

6.1.5. The preparation for the mounting of the axial fixing elements

Usually, the axial mounting of the inner rings is done through supporting sleeves and covers or axial lock nuts, mounted on the frontal surfaces of the shafts.

At the axial fixing elements there are not accepted the following surface defects:

- local wears
- cracks and pinches
- sticking marks
- inclusions

The supporting sleeves are to be verified with the aid of the micrometer gauge.

The shape deviations of the axial fixing elements must be chosen in the same precision class with the one of the assembled bearings.

The measures taken both on the shafts, housings and fixing elements will be done in clean rooms at a mean temperature of 20°C and a relative humidity of 55%.

Before measuring the devices, the micrometer gauges and precision gauge devices will be introduced in the room waiting four hours to get them to the temperature inside.

The measuring devices and gauges will be carefully kept in their cases, in clean rooms, dust free and will be kept away from chokes and vibrations.

With the “go” and “not-go” gauge will be checked the inner and the outer threads, the chamfers and grooves.

6.2. Bearing mounting devices

6.2.1. Generalities

The operational safety of bearings depends highly on their correct mounting and dismounting on the operation site.

The non-observance of the requirements regarding the bearings mounting and dismounting in view of their maintenance often leads to important prejudices that may compromise assemblies perfectly designed from the technical point of view.

The diversity of bearings type dimensions and their operation conditions (load, rotation speed, temperature) require different methods for their mounting and dismounting with adequate tools and devices.

The basic idea in conceiving any bearings mounting device is that the exterior forces applied to the bearing when pressing must not be transmitted through the rolling elements. If this principle is not observed, because of the pressing forces, impressions could appear on the bearings raceways that will make it unusable after a certain running time.

The devices must be as simple as possible constructively and secure a uniform and symmetrical disposition of the pressing forces on the contact surfaces. They must be comfortable and ensure a raised productivity in the mounting process.

6.2.2. Mounting of bearings with cylindrical bore

Mounting of bearings in housings and shafts fitted with interference fit is done by means of mechanical, thermal or hydraulic devices.

The pressing force must be transmitted only through the ring that causes with the shaft or the housing the interference fit avoiding its transmission through the rolling elements.

In small size bearings, mounting (bore diameter less than 50 mm) with intermediate fits or with interference fit in housing and/or shaft are used special sleeves with one or two ribs on which there are applied smooth strokes with a hammer. The use of sleeves guarantees the uniform distribution of force (figures 6.6, 6.7)

In order to ensure a progressive and continuous application of the pressing force, mechanical presses or hydraulic presses. If a non-separable bearing must be mounted in the same time on the shaft and in the housing, between the bearing and the mounting sleeve a plate is inserted to transmit uniformly the force on the frontal faces of the rings. If both bearing rings must form interference fittings, a sleeve whose front surface, in the shape of two circular rims, lies simultaneously both on the inner and the outer rings, is used (figure 6.7).

In the case of dismounting bearings, the rings could be mounted separately on the shaft, respective in the housing, which is favorable mainly when interference fits for both rings are practiced. The medium size bearings (with the bore diameter between 50 and 100 mm) and large size ones (with the bore diameter between 100 and 200 mm) cannot be cold pressed on the shaft or in the housing due to the increase of pressing forces with the bearing size increase. Thus, the non-separable bearings or the inner rings of the separable bearings are heated before mounting. If a non-separable bearing must be simultaneous mounted on the shaft and in housing, then it is inserted between bearing and sleeves, a supporting plate to evenly disperse the pressing force (figure 6.8). The temperature difference, required between the bearing ring and the interlinked part, depends on the fitting and the size of the bearing.

Bearings must not be heated over 110°C in order not to cause alterations within the internal structure of steel thus, resulting in dimensional variations and decrease of their hardness.

At the determination of the heating temperature must be taken into account the distance between the heating source and the mounting places since bearing cooling takes place during transportation. Local overheating must be avoided. The protected bearings or sealed bearings (2Z and 2RS) are not heated before mounting.

Oil baths, heating housings or electrical heating plate are used in bearings heating. In case of bath heating an anticorrosive oil is used, with low viscosity which easily leaks from the bearing when it is rotated upon removing from bath. An example of heating environment is the transformer oil.

As it can be seen in figure 6.9, the bowl is seated on an electrical heating plate. The oil temperature is checked with a thermometer, but it is preferred an automatic adjustment of temperature. The bath is fitted with a grill (situated at 60 - 70 cm from the bottom) to prevent the bearing from coming in direct contact with the heating plate and the possible impurities in the bath from entering the bearing at the same time. The oil must cover completely the bearing.

The bearings heated on the electrical plate must be turned several times for a uniform heating and to avoid local overheating. The heating time of the bearing is of 30 - 50 min, according to the bearing dimensions.

The temperature of the electric heating plate must be adjusted with a thermostat.

To obtain an enhanced productivity in case of a series production, other devices and heating equipment can be used (ex: the inner rings of the cylindrical bearings type NU, NJ and NUP can be heated before mounting with extraction electric devices or with a thermal dismounting ring as in figure 6.10, or with a dismounting thermal-ring figure-6.11).

The medium size and large size bearings could be mounted through the induction heating devices. These are, first of all, heated to a temperature greater than the room temperature by around 80°C.

The induction heating devices contain a coil inductor and a power group fitted with several voltage steps, time relays and thermal protection relays for ring heating. The separable inner ring of the bearing inserted into the inductor bore and kept there for a short time (about 80 sec) is heated through Foucault currents formation.

After heating, the demagnetized rings in the same device are removed and mounted on the shaft.

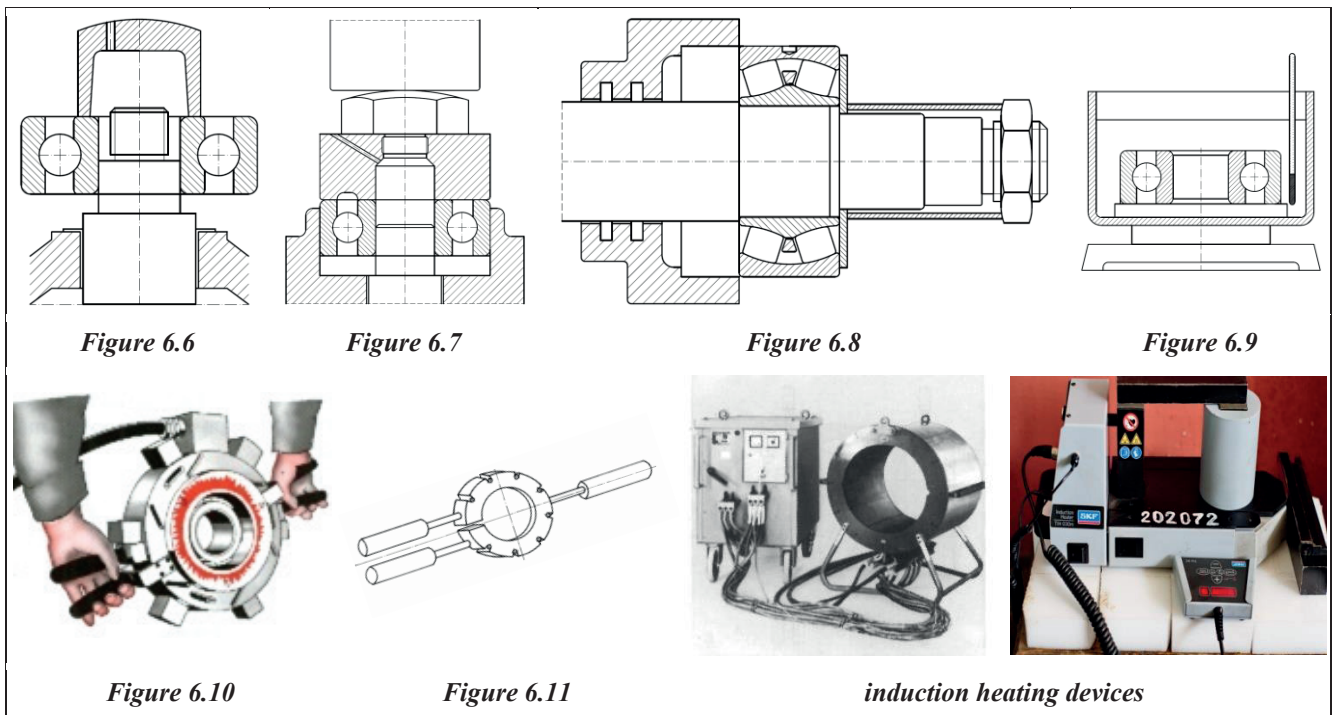

Figure 6.6

Figure 6.7

Figure 6.8

Figure 6.9

Figure 6.10

Figure 6.11

induction heating devices

6.2.3. Mounting of cylindrical roller bearings

Mounting of the inner ring or of the outer ring into the assembly must not be done in force. If there is a considerable resistance, the ring with the rollers must be alternatively rotated during mounting (figure 6.12). To facilitate the mounting and avoid the bearing damage, the use of specially constructed auxiliary rings is recommended (figure 6.13 and 6.14).

After the mounting of cylindrical bearing (type N or NU), the axial displacement of a ring against the other must be measured and checked.

6.2.4. Mounting of tapered bore bearings

The tapered bore bearings could be mounted directly on shafts, adapter sleeves or withdrawal sleeves. The mounting of these bearings is done only with interference fit.

In table 6.1 are given for the self-aligning spherical roller bearings the values of the radial clearance reduction after mounting according to the initial clearance.

The small size tapered bore bearings mounted directly on the shaft, adapter sleeve or withdrawal sleeve after fixing on the tapered shaft are axially displaced through some lock nuts type KM and washers type MB, (figure 6.16 a, b, c). The medium size bearings are axially displaced using a special nut (figure 6.17) with

several screws which is afterwards dismantled and replaced with an axial lock nut.

In medium and large size bearings special mounting hydraulic presses (figure 6.18) or special hydraulic nuts are used, for example in figure 6.19 a. (The mounting of a tapered bore bearing directly on the tapered shaft), figure 6.19 b (the mounting of a bearing with adapter sleeve), figure 6.19 c (the mounting of a bearing with withdrawal sleeve).

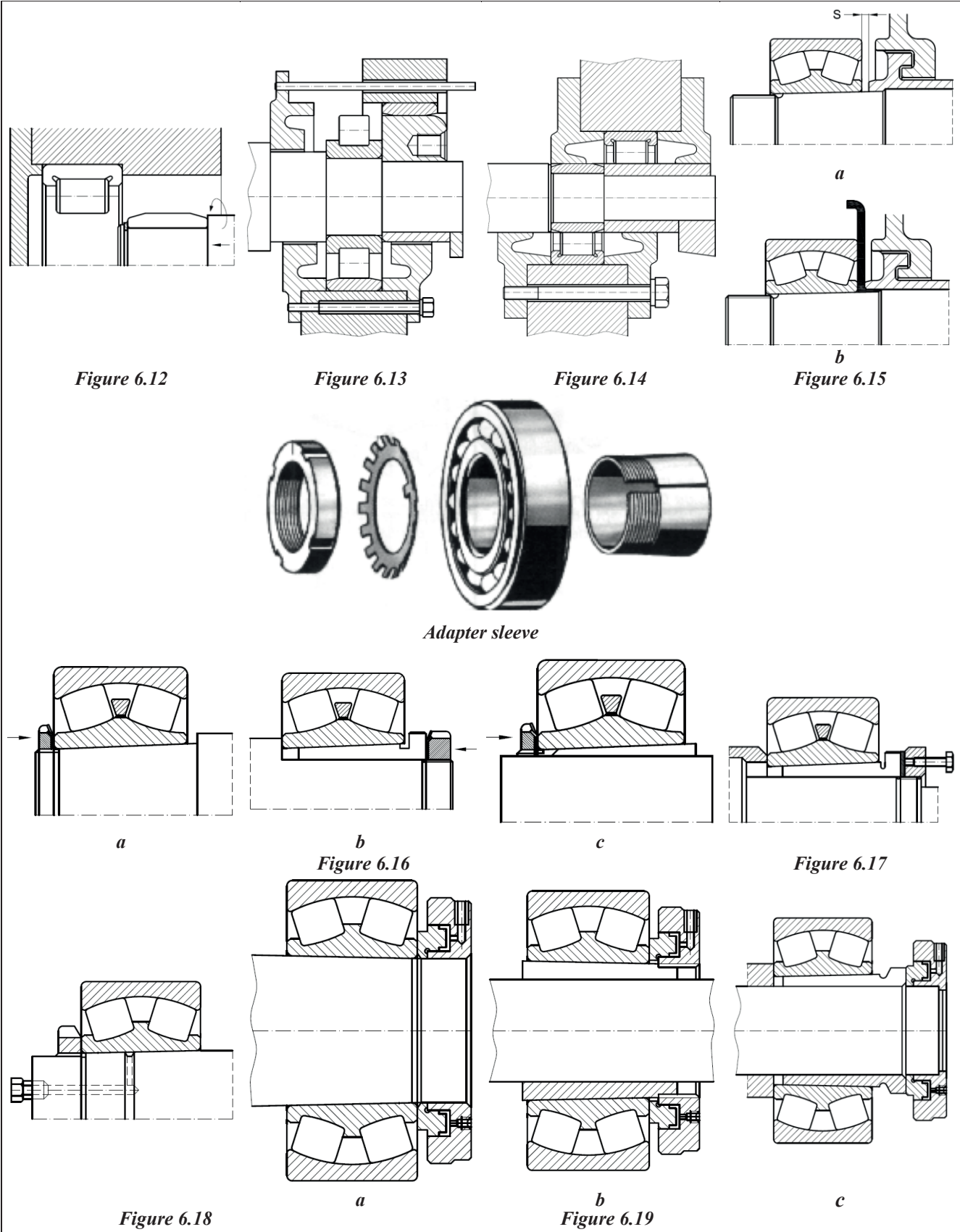

Table 6.1

Inner diameter, d		Reduction of radial clearance		Axial displacement a, taper 1:12				Axial displacement a, taper 1:30				Minimum radial clearance after mounting, for clearance group				
				On tapered shaft		On tapered sleeve		On tapered shaft		On tapered sleeve						
over	up to	min	max	min	max	min	max	min	max	min	max	min	max	Normal	C3	C4
30	40	0,02	0,025	0,35	0,4	0,35	0,45	-	-	-	-	0,015	0,025	0,04		
40	50	0,025	0,03	0,4	0,45	0,45	0,5	-	-	-	-	0,02	0,03	0,05		
50	65	0,03	0,04	0,45	0,6	0,5	0,7	-	-	-	-	0,025	0,035	0,065		
65	90	0,04	0,05	0,6	0,75	0,7	0,85	-	-	-	-	0,025	0,04	0,07		
90	100	0,045	0,06	0,7	0,9	0,75	1	1,7	2,2	1,8	2,4	0,035	0,05	0,08		
100	120	0,05	0,07	0,7	1,1	0,8	1,2	1,9	2,7	2	2,8	0,05	0,065	0,1		
120	140	0,065	0,09	1,1	1,4	1,2	1,5	2,7	3,5	2,8	3,6	0,055	0,08	0,11		
140	160	0,075	0,1	1,2	1,6	1,3	1,7	3	4	3,1	4,2	0,055	0,09	0,13		
160	180	0,08	0,11	1,3	1,7	1,4	1,9	3,2	4,2	3,3	4,6	0,06	0,1	0,15		
180	200	0,09	0,13	1,4	2	1,5	2,2	3,5	4,5	3,6	5	0,07	0,1	0,16		
200	225	0,1	0,14	1,6	2,2	1,7	2,4	4	5,5	4,2	5,7	0,08	0,12	0,18		
225	250	0,11	0,15	1,7	2,4	1,8	2,6	4,2	6	4,6	6,2	0,09	0,13	0,2		
250	280	0,12	0,17	1,9	2,6	2	2,9	4,7	6,7	4,8	6,9	0,1	0,14	0,22		
280	315	0,13	0,19	2	3	2,2	3,2	5	7,5	5,2	7,7	0,11	0,15	0,24		
315	355	0,15	0,21	2,4	3,4	2,6	3,6	6	8,2	6,2	8,4	0,12	0,17	0,26		
355	400	0,17	0,23	2,6	3,6	2,9	3,9	6,5	9	6,8	9,2	0,13	0,19	0,29		
400	450	0,2	0,26	3,1	4,1	3,4	4,4	7,7	10	8	10,2	0,13	0,2	0,31		
450	500	0,21	0,28	3,3	4,4	3,6	4,8	8,2	11	8,4	11,2	0,16	0,23	0,35		
500	560	0,24	0,32	3,7	5	4,1	5,4	9,2	12,5	9,6	12,8	0,17	0,25	0,36		
560	600	0,26	0,35	4	5,4	4,4	5,9	10	13,5	10,4	14	0,2	0,29	0,41		
630	710	0,3	0,4	4,6	6,2	5,1	6,8	11,5	15,5	12	16	0,21	0,31	0,45		
710	800	0,34	0,45	5,3	7	5,8	7,6	13,3	17,5	13,6	18	0,23	0,35	0,51		
800	900	0,37	0,5	5,7	7,8	6,3	8,5	14,3	19,5	14,8	20	0,27	0,39	0,57		
900	1000	0,41	0,55	6,3	8,5	7	9,4	15,8	21	16,4	22	0,3	0,43	0,64		
1000	1200	0,45	0,6	6,8	9	7,6	10,2	17	23	18	24	0,32	0,48	0,7		
1200	1250	0,49	0,65	7,4	9,8	8,3	11	18,5	25	19,6	26	0,34	0,54	0,77		

6.3. Performance test

Test starting must be done after the following verifications have been carried out:

- a. tightening screws and nuts;
- b. checking the radial clearance of the bearing;
- c. hand rotation test of bearings (if the assembly allow this test).

Attention! These two verifications (b and c) must also be performed before bearing mounting, so:

- b. Check the radial clearance of bearings using thickness gauges which are inserted:
 - between the rollers and the raceway of the outer ring at the upper part for the spherical bearings;
 - between the rollers and raceway of the inner ring at the lower part for bearings type NU, NJ;
 - between the rollers and the raceway of the outer ring at the lower part for type N bearings.

Note: In case of deep groove ball bearings the clearance cannot be checked after mounting and before mounting, this operation requires the existence of a special device.

- c. At the hand rotation test, it must be checked if bearings are easily rotating without interruptions, with low and uniform noise. Before the rotation test, a few drops of transformer oil could be inserted in the bearing to avoid dry friction. If the hand rotation is normal, the sealing is further checked, the required quantity of lubricant is inserted and after that the operation test is performed. During the latter, the assembly must be verified mainly regarding the noise and easy rotation.

The noise check during operation should be carried out by a specialized worker who is supposed to listen to the bearing noise, a worker capable to make difference between the noise produced by the bearing and the noise of the other moving parts of the machine.

This check can be done with an acoustic tube, long hilted screwdriver.

A correct mounted bearing must operate uniformly, without shocks and unusual noise. A dump interrupted noise shows that the bearing is dirty and a “whistling” sound indicates that the bearing is not enough lubricated or there are frictions between the bearing and its connection pieces.

In both cases it is necessary to stop the test to verify the bearing mounting and its state.

During the performance test the bearing temperature must be frequently verified. Under normal conditions this must not exceed with more than 20 - 30°C the temperature of the environment.

There are not allowed temperatures over 80°C.

In the first moments of the test, because of the friction between the sealing and the shaft, a sudden increase of the temperature above normal values may occur, but in a certain period of operation this increase is stabilized.

If the increase of the temperature has a pronounced and continuous character, the test must be interrupted to find the reasons for which the bearing heated.

In case in that at the assembly dismounting there are no faulty bearing or adjacent parts and the aspect of the pieces is normal, the correct selection of the bearing for the operating conditions must be checked.

We recommend a minimal loading ($F_{r \min}$) in bearing assembly test functioning, mainly in case of high rotation speeds such as:

$$F_{r \min} = 0.01 \times C_r \text{ - for radial ball bearings;}$$

$$F_{r \min} = 0.02 \times C_r \text{ - for radial roller bearings;}$$

$$F_{r \min} = 0.04 \times C_r \text{ - for full complement bearings.}$$

where:

- C_r = basic dynamic load taken from the bearing catalogue.

This is necessary in diminishing the effect of inertial forces which cause sliding effects between the raceway and elements with a negative influence upon the operating conditions (additional friction, temperature increase).

The performance test with the loaded bearings as in the operating conditions will allow to notice the possible faults and to remove them thus ensuring a good running of the assembly.

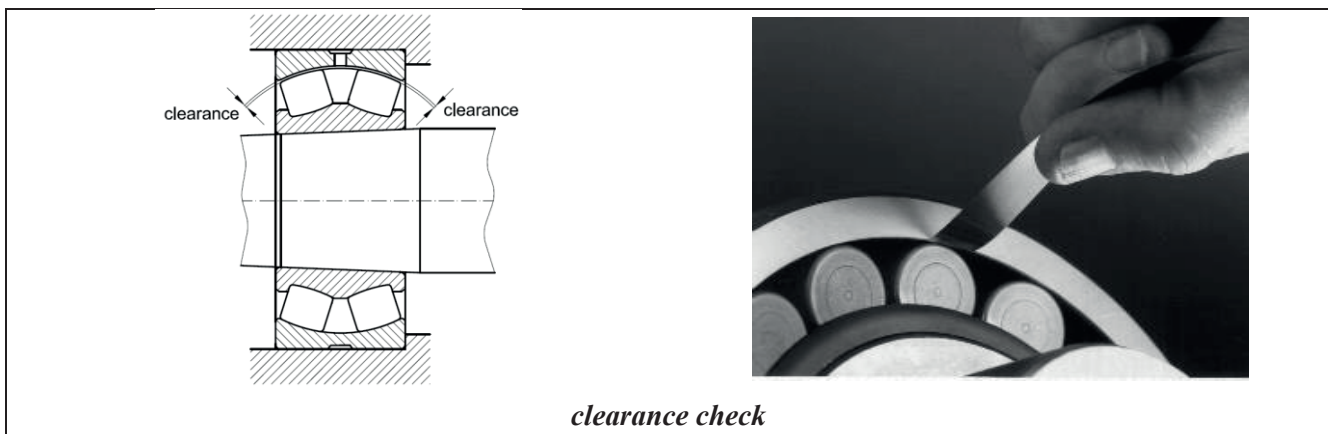

7. DISMOUNTING OF BEARINGS

7.1. Rules in bearings dismounting

Bearings dismounting imply the same measures described in the above section (Bearing Mounting).

Many users do not pay special attention to this operation, they don't know and don't apply dismounting methods.

The reasons that determine the necessity of roller bearings dismounting are different, such as:

- faulty mounting;
- regular wear of bearings;
- complete damage;
- device repair and general repair of bearings;

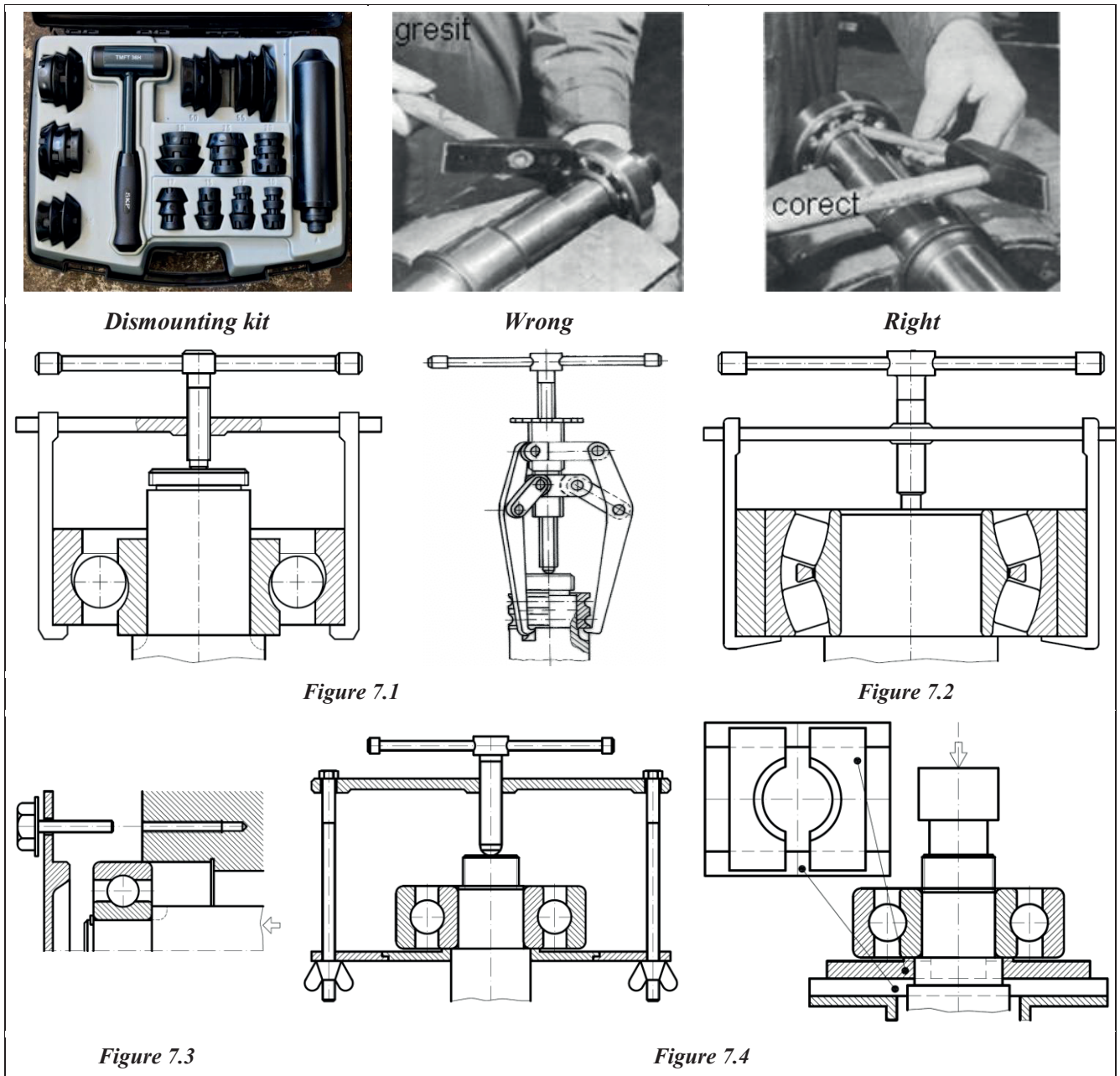

Thus, bearing dismounting must be done carefully during its taking out even from the shaft and from the housing. The same attention must be paid to non-operable bearing, whose inspection is useful to determine the causes of damage.

If the bearing is completely damaged, precaution measures at its taking out are pointless, in this case the dismounting method must exclude the possibility of damaging the surrounding parts or affecting the exploitation qualities of the machine in running, device etc.

The problem of ensuring cleanliness conditions of the dismantled bearings must be considered differently according to their situation.

When dismantling a damaged bearing, it is not necessary to observe the maintenance - washing rules, if the user dismantles good bearings or bearings for inspection cleanliness is essential.

Before bearing dismantling, it is recommended to take all the necessary measures to ensure cleanliness at work site. In bearing dismantling, the worker wear gloves and use clean tools.

If the bearing functioned and there are reasons to suppose that impurities penetrated inside it, it is necessary that immediately after dismantling the bearing must be washed by the methods presented.

7.2. Bearing dismantling devices

Bearings dismantling from housings and shafts is done with specific means according to the fitting type, bearing type and size, necessity of further using the respective bearing, housing or shafts.

There could be distinguished two main categories during the dismantling operations:

1. Cylindrical bore bearing dismantling;
2. Taper bore bearing dismantling.

The dismantling of bearings from housings and shafts with interference fit is carried out by mechanical, thermal or hydraulic means in reversed order than the mounting operations, dismantling first the elements less tightened.

The extraction force must be transmitted only through the ring in contact with the shaft or the housing of the interference fit, avoiding its transmission through the rolling elements.

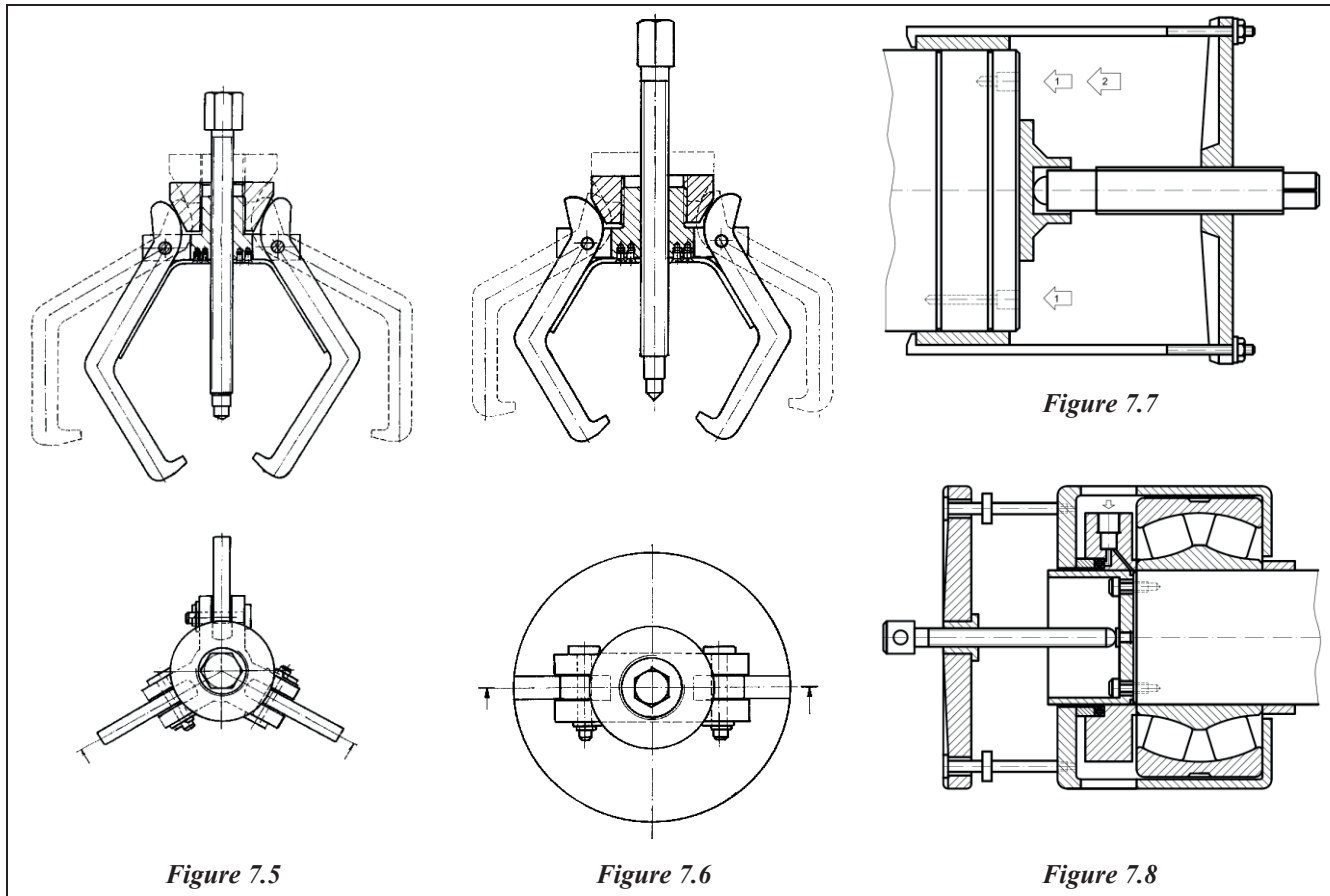

Figure 7.5

Figure 7.6

Figure 7.8

7.2.1. Dismounting of bearings with cylindrical bore

For the small dimension bearing (bore smaller than 50 mm) from the separable or non-separable bearings category, tightening mounted, the extraction is done using a soft steel or copper mandrel with rounded edges and a hammer through which are applied strokes on the inner ring on its side face with the aid of the mandrel along the circumference of the ring. It must have care not to touch the shaft or the inner of the bearing, the strokes being able to determine irreparable damages.

If it is not required the further use of the roller bearing, its dismantling may be done using a mechanical press, figure 7.1 and figure 7.2, or the specific construction of the shaft, figure 7.3. The best extraction mode is presented in figure 7.4 when it is used a small capacity mechanical or hydraulic press, the shaft with the bearing being able to be moved in its working zone.

The elements used for dismounting are made on dimensional ranges.

If the shafts with the bearings cannot be moved, there are used two or three arms mechanical presses (figure 7.5 and 7.6). These are adjustable tools allowing a great range of dimensions.

In the case of medium and large size bearings it is recommendable the use of the oil injection method, figure 7.7, or 7.8, which develops great extraction forces. Through this method it is followed the creation of a oil film between the shaft and the inner ring facilitating thus the slide. In the case of dismounting after a long operation period in improper lubrication conditions which allowed oxidation between the contact surfaces, to prevent their deterioration it is recommended the use of a oil with antioxidant additives.

Medium and large size bearings and rings serial dismounting from the shafts is greatly facilitated using the thermal means.

The bearing or the separable inner ring is heated up to 80 - 100°C so that through dilatation it must be easily removed from the shaft.

There are several heating modalities depending on the repeatability of the dismounting operation and to the dimensions of the dismounting element.

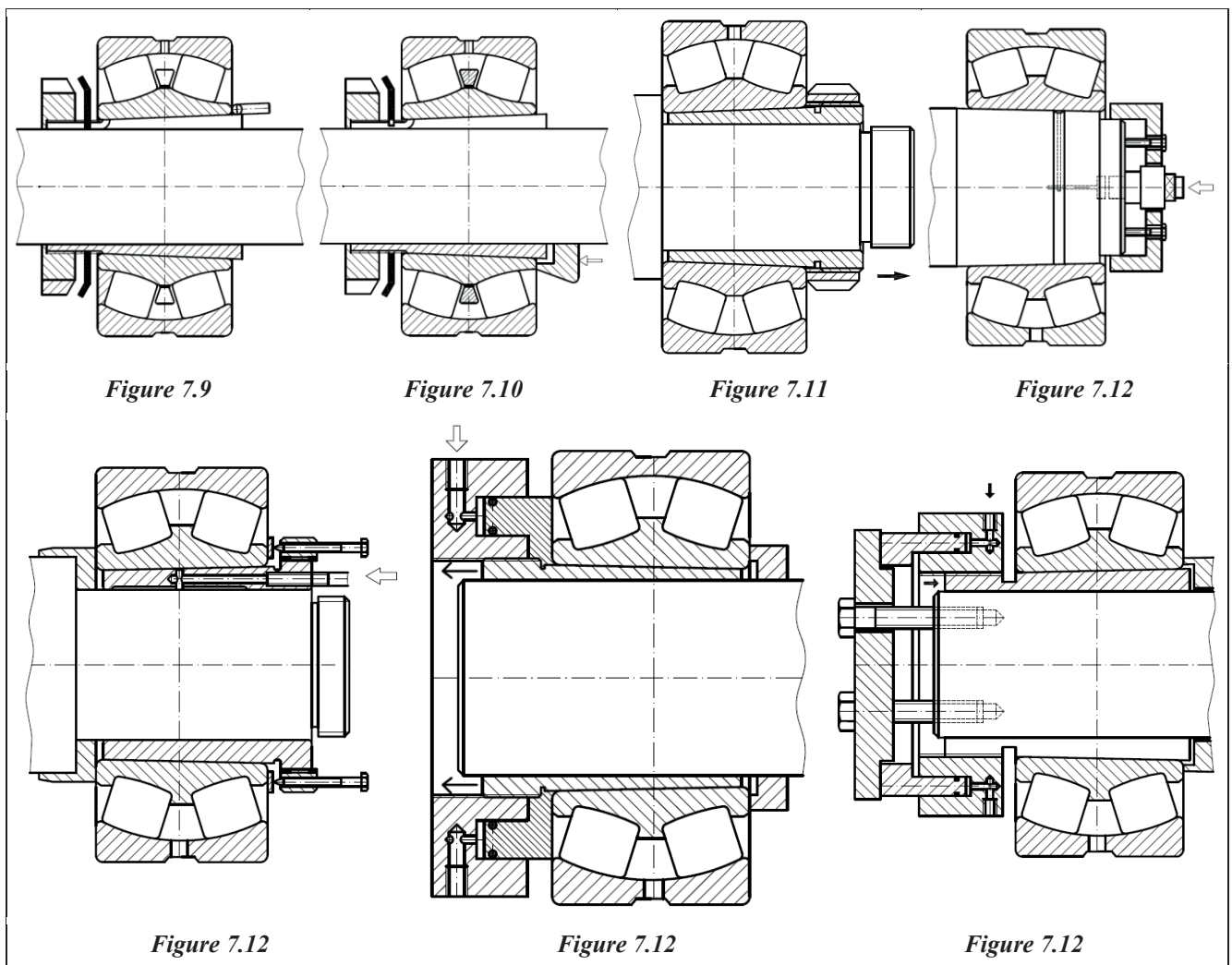

Thus, the heating may be done:

- a. in mineral oil baths having the temperature of 80 - 100°C so that there are heated only the ring or the bearing protecting the rest of the shaft with asbestos or cardboard. The extraction is done by mechanical devices.
- b. for the rings with medium and large dimensions, it is simple to use an aluminum made extractor ring (see figure 6.11 heated on the electrical heating plate or through induction up to about 220°C after which the ring to be dismounted is inserted and tightened with the two joined rings.

After about 20 - 30 seconds the ring dilates enough to allow its easy extraction. To protect the raceways, the ring is smeared with silicone oil (which is resistant to oxidation).

7.2.2. Dismounting of taper bore bearings

The dismounting of the small taper bore bearings mounted directly on the shaft is achieved through the application of the tool (mandrel, pipe, half ring) directly on the side face of the inner ring and after that with gently strokes dismounting is produced.

In case of small bearings mounted on sleeves there must be opened first the lock washer and after that unscrew few turns, the lock nut.

The tool, which can be a tool or a mandrel (figure 7.9) or an intermediary half ring (figure 7.10) is placed in position and then, with strokes uniformly distributed on the entire circumference, the bearing is dismounted.

The withdrawal sleeve could be also dismounted mechanically. To this purpose it can be used the nut axially fastened after removing the shaft's nut and lock washer (figure 7.11) by tightening the nut with the special wrench till the bush extraction.

The greater are the dimensions of the roller bearings (boring greater than 100 mm) the greater must be the dismounting forces.

In this case it is used the method of oil injection between the mounting surfaces or the hydraulic nuts.

Oil injection could be applied in the case of the bearings directly mounted on the shaft through the special provided grooves.

Oil injection procedure is also applied to the bearings mounted on the adapter sleeve or withdrawal sleeves (figure 7.12 and figure 7.13) which have provided grooves for this purpose.

The decrease of the physical effort and dismounting time are achieved by the use of the hydraulic nuts which are used both for removing from the withdrawal sleeves (figure 7.14) and for removing from the adapter sleeve (figure 7.15).

Insertion of pressurized oil into the hydraulic nuts is done with the aid of the manual presses. The oil injection method may be combined with the use of the hydraulic nut in case of large size bearings or for blocking them on the shaft.

8. PREVENTIVE MAINTENANCE OF BEARINGS

The inspection of the devices and equipment containing bearings during operation and their scheduling for the reliable maintenance practices, became an usual and very important practice. So, even we can determine the bearings life, the operating conditions are the ones that decide their lifetime in the assembly where mounted. The heavier are the operating conditions, more frequent will be the interventions at the bearings assemblies, with direct implications on the costs. Thus, the condition monitoring of the bearings and of the other pieces of the assembly, could give important information about the bearing damages, allowing scheduling a current replacement before total destruction. In such a manner there are avoided the unscheduled downtime, often dangerous, through scheduled stoppages for revision and maintenance. The frequency of the bearing operation check depends on the importance of the machinery where this is mounted, and on environmental conditions in which the bearing operates.

If there is no permanent surveying system for the bearings (monitoring system), the surveillance is based on the individual senses of the maintenance staff. Vibration, noise, temperature increase, lubricant leakage are alarm signals that require a thorough verification of the bearings.

The first verifications on the bearings are that one's effected during the performance test.

Notice: A bearing assembly must not be rotated without load or lubrication!

The noise check during operation is done with the aid of the dedicated instruments like shock - pulse meter or by listening with a stethoscope, acoustic tube or wooden stick. It must be continuous and even. The irregularities of the noise (grinding sound) or its transformation into a sharp whistle are signs of certain damages caused by the penetration of dirt into the bearing or because of the lubricant lack, or because of erroneous processed or mounted pieces in the assembly.

The temperature variation check is done with thermometers or thermocouples and is mentioned in diagrams. The bearings are considered good when the temperature increase is continuous and even, attaining the maximum allowable temperature after a period of time which varies according to the type and size of the bearing. The sudden increase of the temperature indicates a leak in the lubrication system, impurities in the lubricant, a wrong selection of the lubricant, an incorrect mounting, overloading or insufficient clearance.

The first verification of the bearings during operation is the visual control of the housing to verify the sealing state, the joints and assemblies and lubrication systems state.

There must be verified: - not to exist sealing defects, manifesting through lubricant leakage; - not to exist lubricant leakage at the sub-assemblies joints; - the existence and status of the lubricating systems, which require periodical cleaning; - the level of the lubricant in the bearing, housing or in the centralized lubrication system, the functioning of the lubricant feeder; - the aspect and the quality of the lubricant (samples of lubricant are taken from the bearing and are compared with the same type of unused lubricant); - the existence of paint discoloration (or of the thermal marks) on the bearing (may point out the excessive increase of the operation temperature).

The verification of the lubricant may give the following information: - the discoloration means the beginning of the aging, mainly when it is less viscid than the sample of unused lubricant; - the dirty color shows contamination of the lubricant with metallic particles from the wear of the housing parts, or with nonmetallic particles from deterioration of the sealing systems; - the limy oil shows water presence.

In all the cases it is recommended to replace the lubricant with the recommended oil or its equivalent.

The maintenance of the greased bearings functionality requires the observance of the recommendations regarding the greasing points, relubrication intervals, the quality of the grease - the recommended grease or its equivalent, cleanliness maintenance of the grease feeding system.

Another check refers to the noise of the bearings during operation. An even and continuous noise indicates a good running of the bearings. Intermittent noise, powerful or accompanied with noises type "strike - knock", shows the bearing damage requiring bearing inspection and/or replacement. It is required the check of the lubricating system and of the lubricant because the main reasons of the premature damage of the bearings are the malfunctions due to incorrect lubrication, poor lubrication or lubricant contamination.

The operation temperature check has in view its sudden increases and the raised, long time persisting values (except in the case of new lubricated or relubricated bearings which presents a natural temperature rise for the first 24 - 48 operating hours). If the loading conditions were not modified, among the reasons for the temperature rise may be a lubricant leakage or an exaggerate increase of the lubricant quantity in the bearing.

9. BEARINGS EXAMINATION. FAILURE REASONS

Normally, if the bearing mounting was correctly done and its operation is designed for the specified loads, speeds and temperatures, with an adequate lubrication, it is assumed that the bearing damage is produced by material fatigue (pitting). If the operation of such a bearing is not interrupted, the peeling will increase rapidly leading to the out of function of the roller bearing with possible damages to the entire assembly.

In the most frequent situations damage occurs from the following reasons:

- faulty mounting of the bearing or of the assembly surrounding parts;
- deviations from the correct geometrical form of the mounting surfaces and non-observance of the tolerances for shaft and housing diameters;
- non coaxially between shaft and housing;
- bearing operation in improper conditions (loads, speeds, temperatures);
- poor lubrication
- inadequate sealing
- inadequate lubricant for the respective application
- flowing of the electric current through the roller bearing.

Usually, the symptoms of bearings damage allow to find out the malfunction reasons and even their removal to ensure a further normal function of the bearing.

Below there are given some examples regarding the most frequent roller bearings damages.

Usually the roller bearings will be replaced if they are presenting the following effects: signs of corrosion on the operating surfaces of the bearing elements and at the inner ring bore; signs of mechanical or electrical pitting; scratches; cracks; pinches; spalling or material losses; deformed or broken rivets; cracked cages; surfaces with a beginning of coloration in yellow, blue, gray or red; imprints, strikes or welding material on the raceways and rolling elements.

The replacement of the roller bearing is recommended as soon as the early manifestations of micro scrapes and peeling pointed out, by the increase of the operation clearance, noises and vibrations during the operation of the bearing. Usually, the scratching of the working surfaces requires the replacement of the bearing because of noise, uneven rotation or bearing blockage.

The poor lubrication inevitably leads to the sudden increase of the friction and overheating of the affected surfaces. The interruption of the lubricant film between the relative motions surfaces under high load and speed conditions, leads to plastic micro deformations and micro welding (appears the loss of the luster and stain on the contact surfaces).

This wear is of adhesive type and has a fast evolution towards material breaks and finally the bearing locking with serious consequences for the entire assembly.

The operation of the bearing in a moist environment or its contamination with water, acid or alkaline substances, leads to the occurrence of the chemical phenomena at the level of the metallic surfaces, corroding them.

The contact corrosion appears in the stationary vibrating or slightly oscillating bearings, on the sliding contacts (rollers ends) and on the rolling contact surfaces manifesting through small brown reddish particles detachment. This type of wear evolve through the increase of the clearance, vibrations and noise, with direct effect on the decrease of the bearing life.

The relative motions of the rings on the shaft or in the housing, due to the use of an inadequate fit or by a faulty execution of the mounting surfaces determine the occurrence of the wear by contact corrosion.

The deterioration of the bearings due to the stationary vibrations resembles as concerns the aspect (crossing tracks on the raceways and on the rolling elements) with the damage determined by the pass of the electric current (electrical pitting). For the occurrence of this type of damage it is enough a voltage of 0,5V to determine a melting temperature in the contact points between the rollers and the rings.

To avoid the occurrence of the two flaws it is recommended:

- to remove the load during bearing stands, or to strain the shaft in axial direction to avoid vibrations;
- to deviate the electric current beside the bearing.

The detection of the flaws presents a special interest for preventing a dangerous further evolution of the flaw with influences over the whole assembly, or machine.

The visual inspection with a certain efficiency in diagnose of faults, requires the dismounting of bearing.

Defects, Causes and Countermeasures

Defect:

- Flaking. Rolling contact fatigue, caused by the repeated stresses developed in the contacts between the rolling elements and the raceways, is described as fatigue. Fatigue is manifested visibly as a flaking of particles material from the surface.
- Pitting: small holes 0.1 mm in depth are generated on the raceway surface by rolling fatigue.

Causes:

- Subsurface initiated material fatigue. The cumulation of load cycles leads to structural changes and fatigue cracks, originating in the loaded zone.
- Faulty mounting and/or handling has produced raceway indentations, spaced at rolling element pitch. Subsequent over-rolling leading to flaking.
- Misalignment during operation; shaft deflection; abutment faces on mating part(s) out-of-square.
- Excessive axial load on a bearing can cause premature fatigue and flaking over the entire circumference of one of the raceways.



Flaking equally spaced at the rollers pitch on the inner ring. Specific to vibration occurrence during running.



Pitting (Flaking) on the surface of the inner ring raceway. Specific after wrong mounting procedure



Apparition of pitting (flaking) on the raceway of the inner ring..

Countermeasures:

- Use a bearing with higher load-carrying capacity if longer life is required.
- Mount bearing correctly using suitable tools. Do not transmit mounting forces through rolling elements. For cylindrical roller bearings, rotate shaft / housing slowly during mounting, if possible.
- Check if bearing type is suitable for the equipment.
- Eliminate misalignment or select a bearing type suitable to accommodate the misalignment.
- Reduce shaft deflection.
- Check the squareness of the abutment faces on mating part(s).
- If appropriate, select a bearing with higher axial load-carrying capacity.
- Control axial load on the bearing.

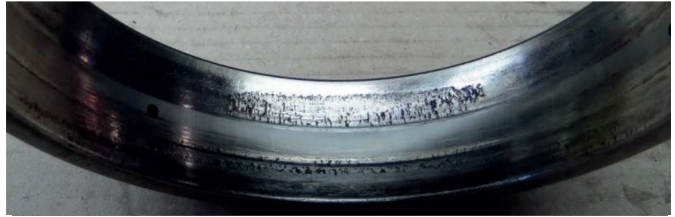

Uneven exfoliation on raceway. Specific to improper position mounting (axially) or axially overloading.

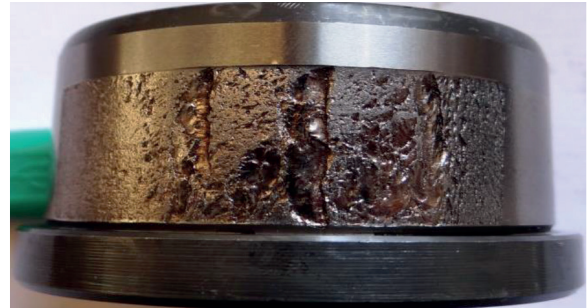

Even exfoliation on loaded area. Normal wear pattern.

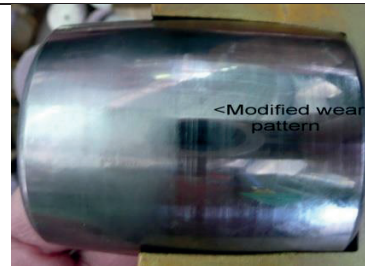

Abrasive wear on rollers raceway.

Defect:

- Abrasive Wear. (“Mat-Frosty” appearance).

Causes:

- Lubricant contamination with abrasive materials, or ingress of abrasive particles from surrounding components.

Countermeasures:

- Improve system cleanliness.



Abrasive wear on outer ring raceway (SRB).



Abrasive wear and vibrations on raceway of a cylindrical inner ring.

Defect:

- Smearing (skidding)

Causes:

- Incorrect design and/or operation. Smearing (skidding) appears between rolling elements and raceways, in a bearing subjected to very light load during rotation, or too high inertia of ball/roller set (high accelerations).
- When smearing (skidding) occurs, the lubrication is inadequate.
- Use of very high running radial clearance.

Countermeasures:

- Reconsider bearing selection (downsize)..
- Follow running-in procedures.
- Select suitable lubricant (viscosity, composition, additives).
- In some cases, pre-loading could be suitable.

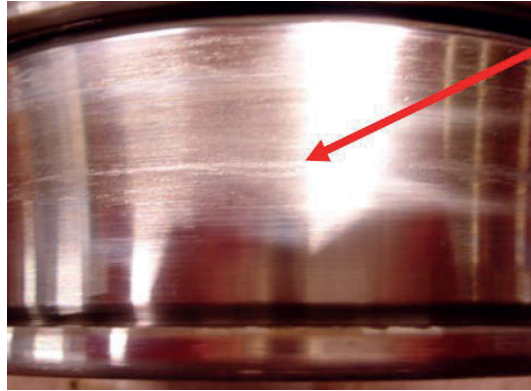

Smearing on inner ring raceway



Smearing on inner ring raceway and roller

Defect:

- Rollers end side and flange wear.
- Cracking and breakage of guiding flanges.

Causes:

- Axial overloading accompanied by inadequate lubrication;
- Excessive deflection of the shaft;
- Wrong axially positioning of the bearing;
- Out-of squareness of mating surfaces.
- Improper mounting (direct blow)

Countermeasures:

- Check and correct the axial clearance of mounted bearing;
- Mount using proper tools and methods;
- Check quality and quantity of lubricant;
- Check axial fixing of adjacent elements.



Wear on inner ring rib face and roller and face of Cylindrical Roller Bearing with rib.



Wear on rollers end face of Cylindrical Roller Bearing.



Damaged central flange due to improper mounting (blow)

Defect:

- Worn cage pockets, seizure marks.

Causes:

- Constrained motion of rolling elements due to lack of clearance or misalignment;
- Excessive vibration;
- Inadequate lubrication;
- Inappropriate bearing selection;
- Improper mounting;
- Overloading.

Countermeasures:

- Check load and mounting conditions;
- Select appropriate clearance and lubrication;
- Consider alternative bearing type or cage.

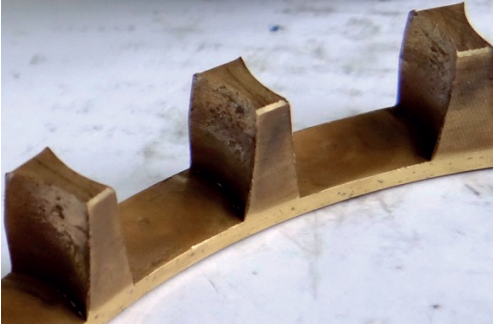

Worn cage pockets and seizure of outer surface



Defect:

- Deformation and severe wear of raceways, rollers and flanges.

Causes:

- Overloading;
- Thermal degradation by heating elements with procedures not recommended;
- Geometrical deviations above limitations of shaft and / or housing;
- Wrong axial misalignment;
- Improper lubrication.

Countermeasures:

- Check loading conditions and lubrication;
- Check the correct choice of bearing type / size and of the operating conditions;
- Check lubrication.



Advanced wear of raceways.



Advanced wear of one rollers row and for one part of outer ring raceway.



Well-worn rollers and raceway.

Defect:

- Outer ring cracking. Fretting corrosion on outside surface.

Causes:

- Improper fitting on housing;
- Oscillating loads;
- Improper / inadequate housing geometry.

Countermeasures:

- Check possible deformation of parts adjacent to the bearing.;
- Reduce / remove shocks during running.

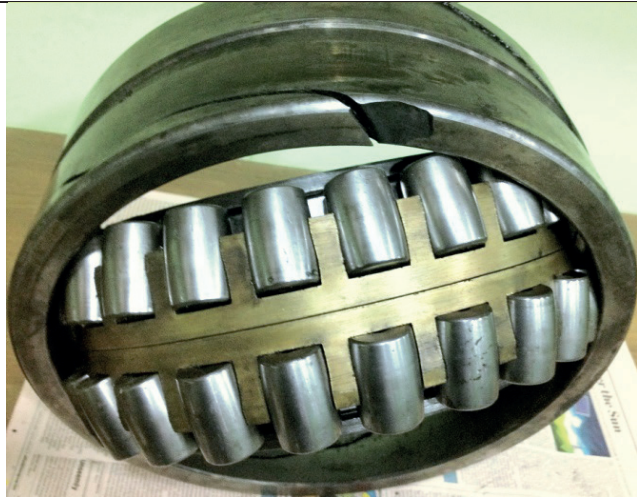

Outer ring crack. Fretting corrosion.

Defect:

- Smearing caused by contact with the shaft shoulder while bearing rotated;
- Rotation of outer ring related to housing;
- Fretting corrosion.

Causes:

- Loose fit between outer ring and housing and a radial load that rotates in relation to the outer ring. Resulting creep of the outer ring in the housing had a polishing effect on the outside surface of the outer ring;
- Shaft deflection;
- Vibrations while running;
- Shaft / housing form deviations;

Countermeasures:

- Choose correct fit taking load and operating conditions into consideration.



Smearing, polished surface of outer ring, fretting corrosion on inner ring bore

Defect:

- Corrosion;
- Lubricant contamination with water.

Causes:

- Moisture penetration;
- Wrong sealing.

Countermeasures:

- Improve sealing;
- Use of anticorrosion additives.



Corrosion. Contaminated lubricant.



Corrosion. Contaminant deposit.

Defect:

- Overheating. Seizure. Uneven wear;

Causes:

- Too small running clearance for one rollers row;
- Overloading of one raceway.

Reasons:

- Uneven or improper heating of inner ring before mounting (improper heating device, too long heating time, too high temperature). As result was an uneven increase of dimensions / degradation of inner ring shape;

Countermeasures:

- Use proper mounting methods and devices.

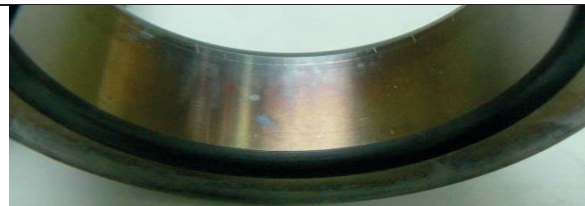

Inner ring bore – color is changed.



Uneven running pattern of inner ring raceway.

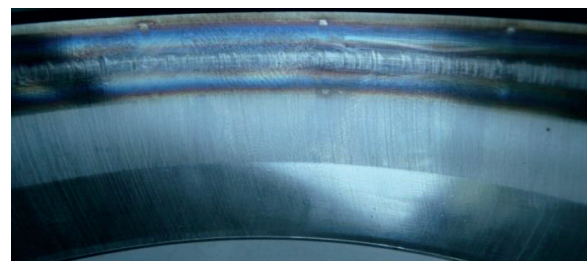

Uneven running pattern of outer ring raceway – pair of above photo.



Appearance of affected rollers row.

Defect:

- Corrosion, unused bearing

Causes:

- Rust on new, unused bearing, caused by improper storage and handling or by insufficient preservation.

Countermeasures:

- Store bearings in dry places with constant temperature and low humidity.
- Remove the bearing from its package just before installation.



Front and outer corrosion on the outer ring

Defect:

- Contact corrosion.

Causes:

- Corrosion marks on raceway at rolling element pitch due to presence of a corrosive liquid while stationary or during storage;
- Water ingress.

Countermeasures:

- Provide suitable preservation for storage.
- Check that the quality of the lubricant is adequate and the re-lubrication interval is correctly specified.
- Check seals.



Corrosion while stationary.



Corrosion while storage.

Defect:

- Different or uneven running patterns

Causes:

- Load unevenly distributed;
- Shaft deflection;
- Axial misalignment over the limits.

Countermeasures:

- Verify running conditions;
- Verify misalignments.

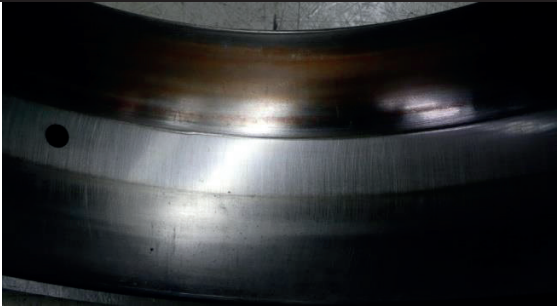

Different running pattern



Uneven running pattern – half raceway scoring



Length uneven running pattern on rollers

Defect:

- Plastic deformation, indentations on raceways spaced at rolling element pitch.

Causes:

- Excessive loads during transportation;
- Mounting or operation when the static load-carrying capacity is exceeded while the bearing stationary, causing plastic deformation of the raceway with indentations spaced at the rolling element pitch.

Countermeasures:

- Prevent static overloading;
- Choose a bearing with high rated basic static load.
- Use protection devices during transportation.
- Ensure proper handling of all machinery that incorporates rolling bearings.

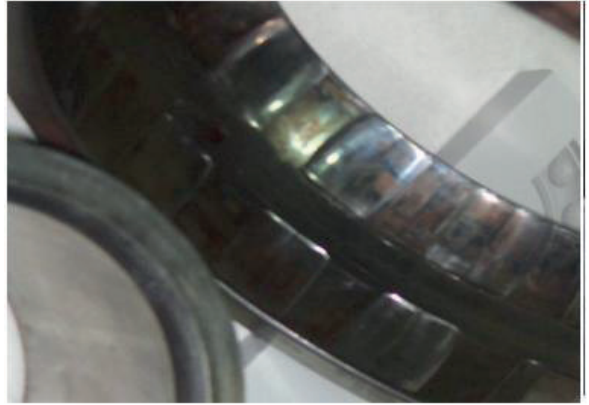
Plastic deformation of raceways – in pair

Defect:

- Fatigue equally spaced as balls pitch.

Causes:

- Impact damage during handling or mounting;
- Transmitting the pressing force through balls;

Countermeasures:

- Use proper devices for mounting (displacement of rings must be simultaneously).

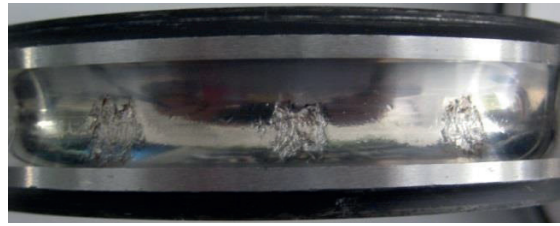

Spalling in the true brinelled areas due to mounting.

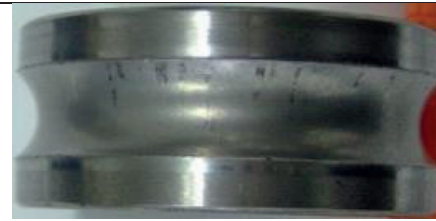

Raceway true brinelling – Deep groove ball bearing

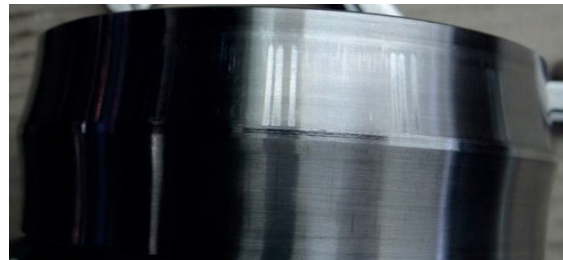

Raceway true brinelling – Spherical roller bearing



Raceway true brinelling – Spherical roller bearing

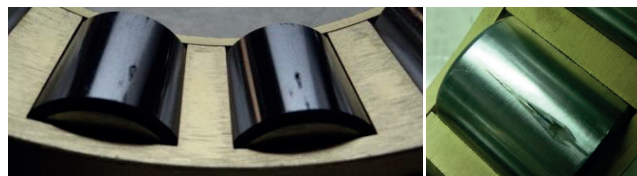

Rollers true brinelling – Cylindrical roller bearing

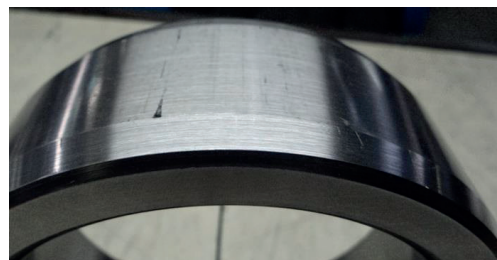

Raceway true brinelling – Cylindrical roller bearing

Defect:

- True brinelling – imprinting

Causes:

- Improper mounting;
- Use of improper tools / devices;

Countermeasures:

- Check mounting procedure and devices
- Do not apply direct blows to bearing elements;
- For inseparable bearings elements, mount displacing simultaneously both rings;
- Do not transmit mounting forces through rolling elements.



URB GROUP



320 Republicii Street,
731108 Barlad,
ROMANIA



phone: +40 235 / 411120, 412120
fax: +40 235 / 413838, 308200
www.urbgroup.com